

2022

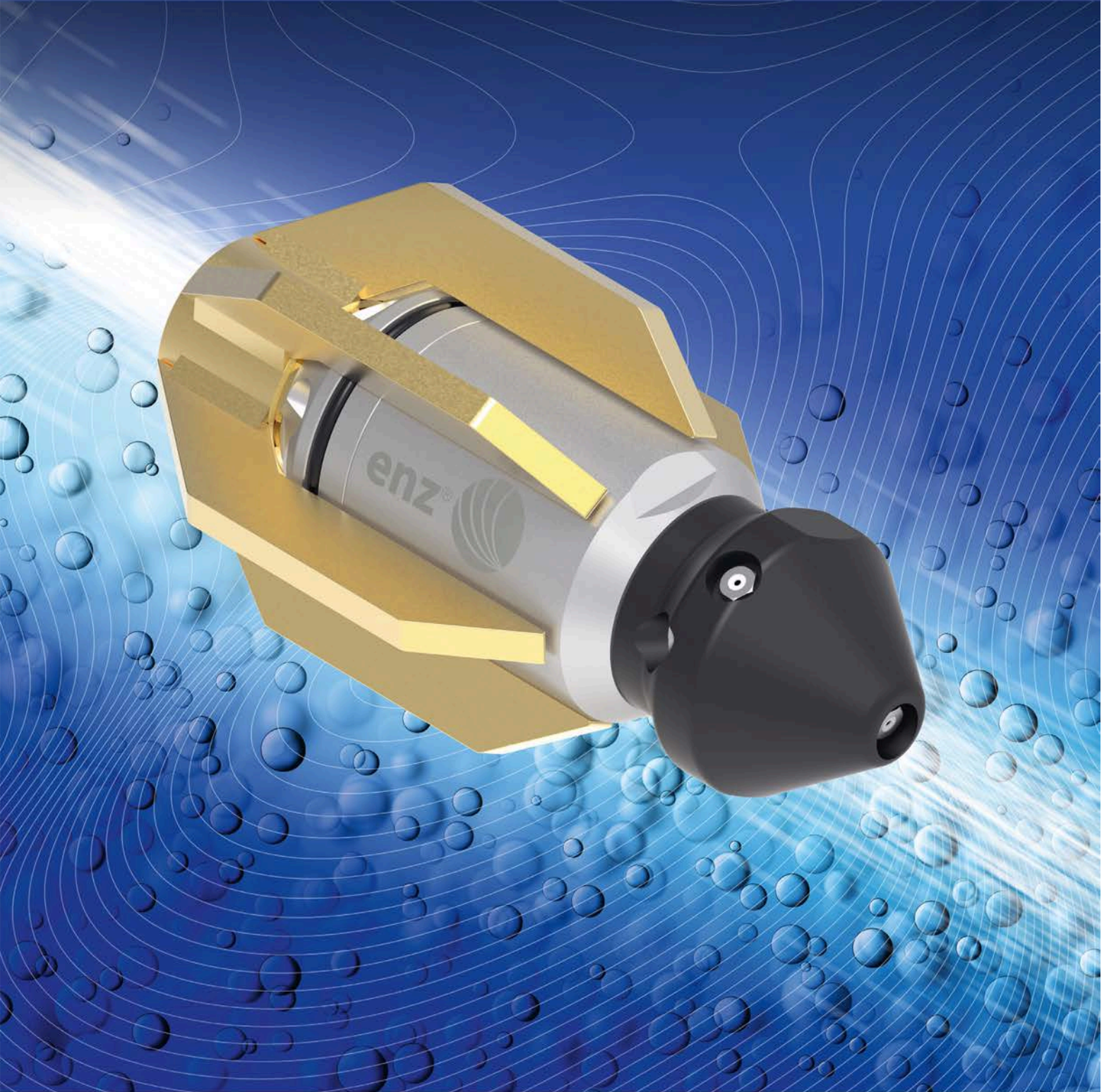

 **SWISS
MADE**

enz[®] 

Legende

	Connecting thread (inch)
	Application range (inch)
	min. G/Min. at 1450 psi min. G/Min. at 14'500/22'000 psi
	Rotating jet
	Thrust jet
	Front jet
	Jet angle backward
	Jet angle forward
	Dimensions [inch]
	Weight [lb.]
	Recycling
	Maximum pressure (psi)

General terms of sale and delivery

General Information

enz® usa inc. / enz® technik ag offers a large range of high quality pipe cleaning tools. Since 1985, through innovative designs, we have assisted the sewer and pipe cleaning industry to remain on the forefront of new and creative technologies. This ensures superior quality and gives you, the customer, a product that is efficient and durable. We are interested in being your Partner and helping you find the best solution for your problems. With our know-how and efforts we will accept any new challenges to help keep you on the forefront of the newest techniques available.

The enz® products

All enz® tools are calibrated to Customer specific Pump and Hose specifications with our own JetCalc® Software to optimize the performance of your tool.

The enz® rotating nozzles are remarkable for their tremendous cleaning efficiency, which is based on a worldwide patented Drive and Brake jets design which increases and decreases the rotational speed with every half rotation therefore limiting the rotational speed.

The resulting pressure vibrations essentially contribute to the disintegration of the deposits. We also carry a complete line of Rotating Chain Scrapers and Percussion Milling Cutters. Our ceramic orifice inserts ensure that enz® tools have an outstanding durability. Our products are covered by International patents.

Warranty / Safety / Liability

enz® Pipe and Channel Cleaning Tools are designed for highest possible performance. The materials and the heat treatment processes are selected for wear resistance and long life. enz® is applying the most up to date manufacturing and quality assurance methods.

The enz® organization is ISO 9001 and ISO 14001 compliant.

General Tool Warranty: enz® warrants the quality of all tools supplied for the duration of 12 months from date of purchase. The warranty is limited to the replacement of faulty parts or the in house repair of faulty tools. No warranty is accepted if tools are not used or maintained in strict compliance with the operating manual supplied by enz®.

Warranty on ceramic nozzles inserts: The orifice diameters of enz ceramic nozzles are warranted for wear for the duration of 5 years from the date of purchase when used with potable water. And 2 years from the date of purchase when used with recycled water. The warranty is limited to the free of charge exchange of worn inserts.

Warranty on Bulldog® nozzles: enz® warrants the internal mechanics of the Bulldog® nozzles for 1 year. No warranty on excessive wear of head or skid body due to prolonged or abusive use. Despite all due care, this documentation may contain errors. enz® technik ag and/or its Subsidiaries shall not be liable for any consequential damage. Technical modifications are reserved.

Our Distributor Network covers the United States and Canada

enz® usa inc

1585 Beverly Ct.

Unit 115

Aurora, IL 60502

Tel. 630-692-7880

Fax 630-692-7885

salesusa@enz.com

www.enz.com

STANDARD NOZZLES	7
ROTATING NOZZLES	33
WIRE ROPE AND CHAIN SCRAPERS	71
IMPACT MILLING CUTTERS	85
CAMERA NOZZLES	101
JET NOZZLE INSERTS	121
ACCESSORIES	127

Standard cleaning nozzles

Made of wear-resistant, hardened steel, provided with front jet insert and blind plug (interchangeable). Angle of jet backwards, sturdy wall thickness, long service life and a minimum of wear and tear. All nozzles from art.30.038 onward are provided with steel, ceramic lined inserts. Because of this, the efficiency is considerably higher compared with those nozzles with drilled holes and the service life is several times longer.





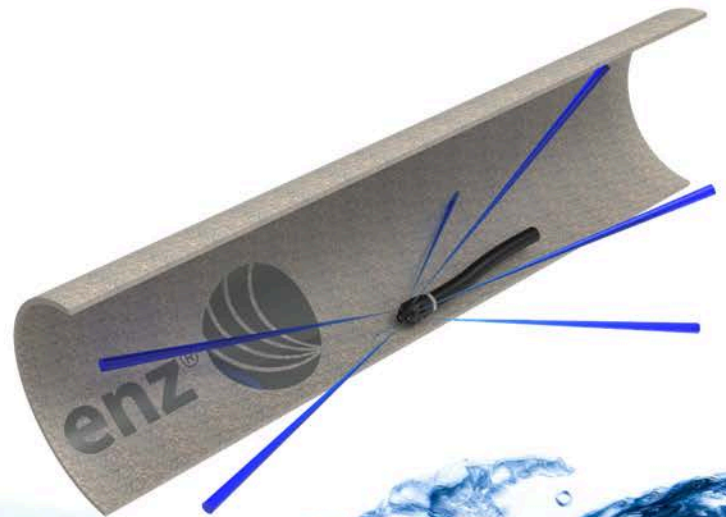





Applications

- Appropriate for removal of sludge deposits and cloggings













Silverline standard cleaning nozzles 1/8" NPT



										
30.012NSL10	1/8" NPT	0.8 - 4	2.6	4 x 0.75	-	25°		0.5 x 0.7	0.02	5,000
30.012NSL10F	1/8" NPT	0.8 - 4	2.9	4 x 0.75	1 x 0.60	25°	0°	0.5 x 0.7	0.02	5,000
30.012NSL15	1/8" NPT	0.8 - 4	4	4 x 0.90	-	25°		0.5 x 0.7	0.02	5,000
30.012NSL15F	1/8" NPT	0.8 - 4	4.2	4 x 0.90	1 x 0.60	25°	0°	0.5 x 0.7	0.02	5,000

Silverline standard cleaning nozzles 1/4" NPT



										
30.0253NSL10F	1/4" NPT	1.2 - 4.3	2.6	3 x 0.80	1 x 0.80	25°	0°	0.7 x 0.8	0.04	5,000
30.0253NSL15	1/4" NPT	1.2 - 4.3	4	3 x 1.10	-	25°	-	0.7 x 0.8	0.04	5,000
30.0253NSL15F	1/4" NPT	1.2 - 4.3	4	3 x 1.10	1 x 0.80	25°	0°	0.7 x 0.8	0.04	5,000
30.0253NSL20F	1/4" NPT	1.2 - 4.3	5.3	3 x 1.20	1 x 0.80	25°	0°	0.7 x 0.8	0.04	5,000
30.0256NSL30	1/4" NPT	1.2 - 4.3	8	6 x 1.10	-	25°	-	0.7 x 0.8	0.04	5,000
30.0256NSL30F	1/4" NPT	1.2 - 4.3	8	6 x 1.00	1 x 0.80	25°	0°	0.7 x 0.8	0.04	5,000

Silverline standard cleaning nozzles 3/8" NPT



										
30.038NSL40	3/8" NPT	1.6 - 5.9	11	6 x 1.30	-	25°	-	1.0 x 0.9	0.15	5,000
30.038NSL60	3/8" NPT	2 - 6	16	6 x 1.50	-	25°	-	1.0 x 0.9	0.13	5,000

Silverline standard cleaning nozzles 1/2"



30.050SL40	1/2"	2 - 8	10.6	6 x 1.2	-	25°	-	1.2 x 1.1	0.13	5,000
30.050SL40F	1/2"	2 - 8	13	6 x 1.2	1 x 1.1	25°	-	1.2 x 1.1	0.13	5,000
30.050SL70	1/2"	2 - 8	18	6 x 1.6	-	25°	-	1.2 x 1.1	0.13	5,000
30.050SL70F	1/2"	2 - 8	21	6 x 1.6	1 x 1.4	25°	-	1.2 x 1.1	0.13	5,000
35.050SL40	1/2"	2 - 8	10.6	6 x 1.1	3 x 1.00	25°	15°	1.2 x 1.1	0.22	5,000
35.050SL70	1/2"	2 - 8	18	6 x 1.4	4 x 1.1	25°	15°	1.2 x 1.1	0.22	5,000

Egg nozzle 1/2"



30.050EI	1/2"	2 - 8	8	6 x M6	1 x M6	25°	-	1.6 x 1.9	0.55	ok	5,000
35.050EI	1/2"	2 - 8	13	6 x M6	4 x M4	25°	15°	1.6 x 1.9	0.55	ok	5,000

Standard cleaning nozzles 3/8" NPT - 1 1/4"



30.038N	3/8" NPT	2 - 6	3	6 x M4	1 x M6	30°	-	1.0 x 1.5	0.15	ok	5,000
30.050	1/2"	2 - 8	8	6 x M6	1 x M4	30°	-	1.2 x 1.9	0.26	ok	5,000
30.075	3/4"	2 - 10	13	6 x M6	1 x M6	30°	-	1.5 x 2.4	0.53	ok	5,000
30.100	1"	6 - 14	32	8 x M8	1 x M8	30°	-	2.4 x 3.3	1.55	ok	3,600
30.100SP20	1"	6 - 14	32	8 x M8	1 x M8	20°	-	2.4 x 3.3	1.55	ok	3,600
30.125	1 1/4"	8 - 16	53	8 x M8	1 x M8	30°	-	2.7 x 4.1	3.02	ok	3,600
35.050	1/2"	2 - 8	13	6 x M6	3 x M4, 1 x M6	30°	15°	1.2 x 1.9	0.26	ok	5,000
35.100	1"	6 - 14	32	8 x M8	4 x M8	30°	15°	2.4 x 3.3	1.55	ok	3,600

Grenade-bomb

This enz® jet nozzle is made of wear-resistant hardened steel. The "grenade" and the "bomb" are joined in the same nozzles. Different jet angles perform together strong traction and effective cleaning. The high efficiency is reached by appropriate water guidance.











Applications

- For removal of loose rubble stone, gravel and soft deposits
- For a previous cleaning before the use of chain flail head or cutter













Grenade-bombs 1/4" NPT



										
40.025N-10	1/4" NPT	1 - 4	3	4 x 0.70	1 x M4	20°	1.0 x 1.6	0.22		7,200
40.025N-30	1/4" NPT	1 - 4	8	4 x 1.30	1 x M4	20°	1.0 x 1.6	0.22		7,200
40.025N-40	1/4" NPT	1 - 4	10	4 x 1.45	1 x M4	20°	1.0 x 1.6	0.22		7,200











Grenade-bombs 3/8" NPT - 3/4"



										
40.038N	3/8" NPT	2 - 4	3	6 x M6	1 x M6	25°	1.5 x 3.2	1.15	ok	7,200
40.050	1/2"	2 - 6	8	6 x M8	1 x M8	25°	1.9 x 3.5	1.89	ok	7,200
40.075A	1/2"	3 - 8	13	8 x M8	1 x M8	10° + 30°	2.3 x 4.6	3.37	ok	7,200
40.075B	3/4"	3 - 8	26	8 x M8	1 x M8	10° + 30°	2.3 x 4.6	3.4	ok	7,200











Grenade-bombs 1"



										
40.100A	1"	5 - 12	40	10 x M10	1 x M10	10° + 30°	3.1 x 6.9	10.80	ok	3,600
40.100A-SP10	1"	5 - 12	40	10 x M10	1 x M10	10°	3.1 x 6.9	10.80	ok	3,600
40.100B	1"	6 - 16	40	10 x M10	1 x M10	10° + 30°	3.9 x 8.1	17.64	ok	3,600



Grenade-bombs 1 1/4"



										
40.100C	1 1/4"	6 - 16	50	10 x M10	1 x M10	10° + 30°	3.9 x 7.7	17.64	ok	3,600
40.125A	1 1/4"	12 - 24	79	10 x M10	1 x M10	10° + 30°	4.3 x 8.7	23.15	ok	3,600

Accessory and wearing parts grenade-bombs



			⊘	📦
40.1004A		Cage with skids (for grenade-bombs 10.3 lbs)	7 - 12	2.91
40.1004B		Cage with skids (for grenade-bombs 17.8 lbs)	8 - 16	3.35

360° Grenade-bombs

This enz® jet nozzle is made of wear-resistant hardened steel. The grenade and the bomb are joined in the same nozzles. Different jet angles perform together strong traction and effective cleaning. The high efficiency is reached by appropriate water guidance.

For optimal all-around cleaning all nozzles are equipped with fan-jet ceramic-steel inserts.











Applications

- For removal of loose rubble stone, gravel and soft deposits
- For a previous cleaning before the use of chain flail head or cutter
- For an all-around cleaning













360° Grenade-bombs 1/2" - 3/4"



										
42.050	1/2"	2 - 6	7.9	6 x M8	1 x M8	25°	1.9 x 3.5	1.89	ok	7,200
42.075A	1/2"	3 - 8	13	8 x M8	1 x M8	10° + 30°	2.3 x 4.6	3.37	ok	7,200
42.075B	3/4"	3 - 8	26	8 x M8	1 x M8	10° + 30°	2.3 x 4.6	3.37	ok	7,200

360° Grenade-bombs 1" - 1 1/4"



										
42.100A	1"	6 - 12	50	12 x M10	1 x M10	10° + 30°	3.1 x 6.9	10.2	ok	3,600
42.100B-12	1"	6 - 16	50	12 x M10	1 x M10	10° + 45°	3.9 x 7.2	17	ok	3,600
42.100B-18	1"	6 - 16	80	18 x M10	1 x M10	10° + 45°	3.9 x 7.2	17	ok	3,600
42.100C-12	1 1/4"	6 - 16	50	12 x M10	1 x M10	10° + 45°	3.9 x 8.1	17	ok	3,600
42.100C-18	1 1/4"	6 - 16	80	18 x M10	1 x M10	10° + 45°	3.9 x 8.1	17	ok	3,600
42.125A	1 1/4"	12 - 24	80	10 x M10	1 x M10	10° + 30°	4.3 x 8.7	23.15	ok	3,600

Drainage channel nozzles

The enz® drainage channel nozzle is suited for cleaning drainage gutters and systems, for example along motorways, in pedestrian zones or parkings. The 0° jets deploy all the cleaning power to the rear, thus preventing contamination of the environment or passing vehicles.





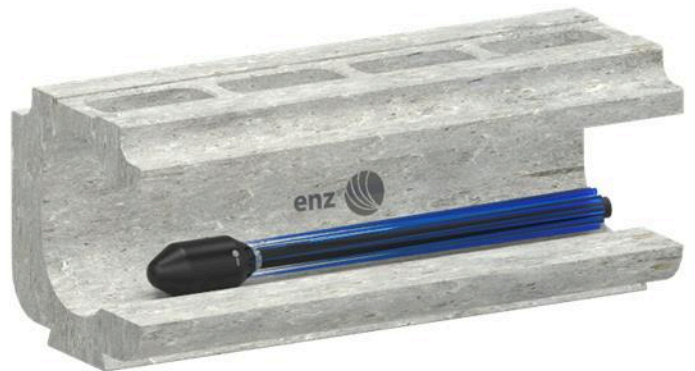





Advantages of the drainage channel nozzle

- No discharge of water from drainage channels
- Optimal flushing performance
- No cleaning of the area after the fact



Drainage channel nozzles 1/2" - 1 1/4"



										
40.050-SPO	1/2"	3 - 8	13	6 x M8	1 x M8	0°	1.9 x 3.5	1.75	ok	7,200
40.075A-SPO	1/2"	3 - 8	13	8 x M8	1 x M8	0°	2.3 x 4.6	3.3	ok	7,200
40.075B-SPO	3/4"	3 - 8	26	8 x M8	1 x M8	0°	2.3 x 4.6	3.3	ok	7,200
40.100A-SPO	1"	6 - 12	40	10 x M10	1 x M10	0°	3.1 x 6.9	10.4	ok	3,600
40.125A-SPO	1 1/4"	12 - 34	73	10 x M10	1 x M10	0°	4.3 x 8.7	23.15	ok	3,600

Chisel point nozzles

Concentrated powerful advance by means of 4 front jet nozzles. The sharp edges cut, break and penetrate through every kind of blockage. Made of wear-resistant, hardened steel. All nozzles from art. 60.038 onward are provided with ceramic inserts. Because of this, the efficiency is considerably higher compared with those nozzles with drilled holes and the service life is several times longer.





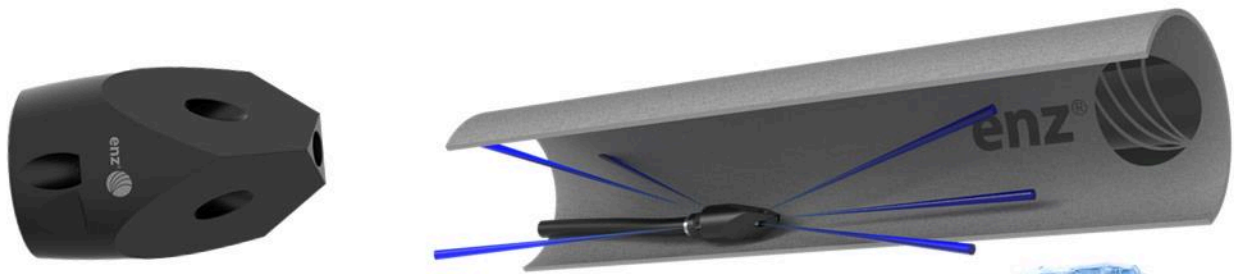





Applications

- Penetrating of completely clogged pipes
- Opening of interlaced roots
- Opening of frozen pipelines













Silverline chisel point nozzles 1/8" NPT - 3/4"



										
60.012NSL15	1/8" NPT	1 - 2	4	3 x 0.95	4 x 0.50	25°	15°	0.6 x 1.0	0.04	5,000
60.025NSL15	1/4" NPT	1 - 2	4	3 x 0.90	4 x 0.60	25°	15°	0.8 x 1.3	0.06	5,000
60.050SL100	1/2"	2 - 6	26	3 x 2.40	4 x 1.10	25°	15°	1.3 x 2.2	0.31	5,000
60.050SL40	1/2"	2 - 6	11	3 x 1.50	4 x 0.80	25°	15°	1.3 x 2.2	0.31	5,000
60.050SL70	1/2"	2 - 6	18	3 x 1.80	4 x 0.90	25°	15°	1.3 x 2.2	0.31	5,000











Chisel point nozzles 3/8" NPT - 1 1/4"



											
60.038N	3/8" NPT	1.1 - 3.9	7.9	3 x M4	4 x M4	20°	15°	1 x 1.7	0.18	ok	5,000
60.050	1/2"	2 - 6	13	3 x M6	4 x M4	25°	15°	1.3 x 2.2	0.31	ok	5,000
60.075	3/4"	2 - 10	26	3 x M6	4 x M4	25°	15°	1.5 x 3.2	0.71	ok	5,000
60.100	1"	4 - 12	40	6 x M6	4 x M6	25°	15°	1.9 x 3.5	1.21	ok	3,600
60.100L	1"	6 - 16	53	6 x M10	4 x M8	25°	15°	2.7 x 7.4	5.95	ok	3,600
60.100L80	1"	6 - 20	53	6 x M10	4 x M8	10°	15°	3.1 x 8.6	10.32	ok	3,600
60.125	1 1/4"	6 - 16	53	6 x M6	4 x M6	20°	15°	2.3 x 3.9	17.6	ok	3,600
60.125L	1 1/4"	8 - 32	79	6 x M10	4 x M8	10°	15°	3.9 x 10.2	18.52	ok	3,600







Chisel point nozzles with centre spire 1/2" - 1 1/4"



											
61.050	1/2"	2 - 6	13	3 x M6	3 x M4	25°	15°	1.3 x 3.2	0.32	ok	5,000
61.075	3/4"	2 - 10	26	3 x M6	3 x M4	25°	15°	1.5 x 4.1	0.72	ok	5,000
61.100	1"	4 - 12	40	6 x M6	3 x M6	25°	15°	1.9 x 4.9	1.24	ok	3,600
61.100L	1"	6 - 16	53	6 x M10	3 x M8	25°	15°	2.7 x 8.7	5.96	ok	3,600
61.100L80	1"	6 - 20	53	6 x M10	3 x M8	10°	15°	3.1 x 10.2	10.37	ok	3,600
61.125	1 1/4"	6 - 16	53	6 x M6	3 x M6	20°	15°	2.3 x 5.2	2.07	ok	3,600
61.125L	1 1/4"	8 - 32	79	6 x M10	3 x M8	10°	15°	3.9 x 11.8	18.57	ok	3,600

Accessory and wearing parts chisel point nozzles



					
0061.0504		Centre spire for Pointed Nozzle 60.050	M4	0.2 x 1.0	0.22
0061.1004		Centre spire for Pointed Nozzle 60.100	M6	0.4 x 1.3	0.22
0061.1254		Centre spire for Pointed Nozzle 60.100L80,	M8	0.4 x 2.0	0.22

Guiding nozzles

The enz® steering nozzle was specially developed for targeted cleaning of pipe inlets. It is used to search for connections in ground pipes so that, for example, cleaning through a house connection can be avoided. The head nozzle on the flexible hose is used to enter the connection.

Applications

- For removal of loose rubble stone, gravel and soft deposits

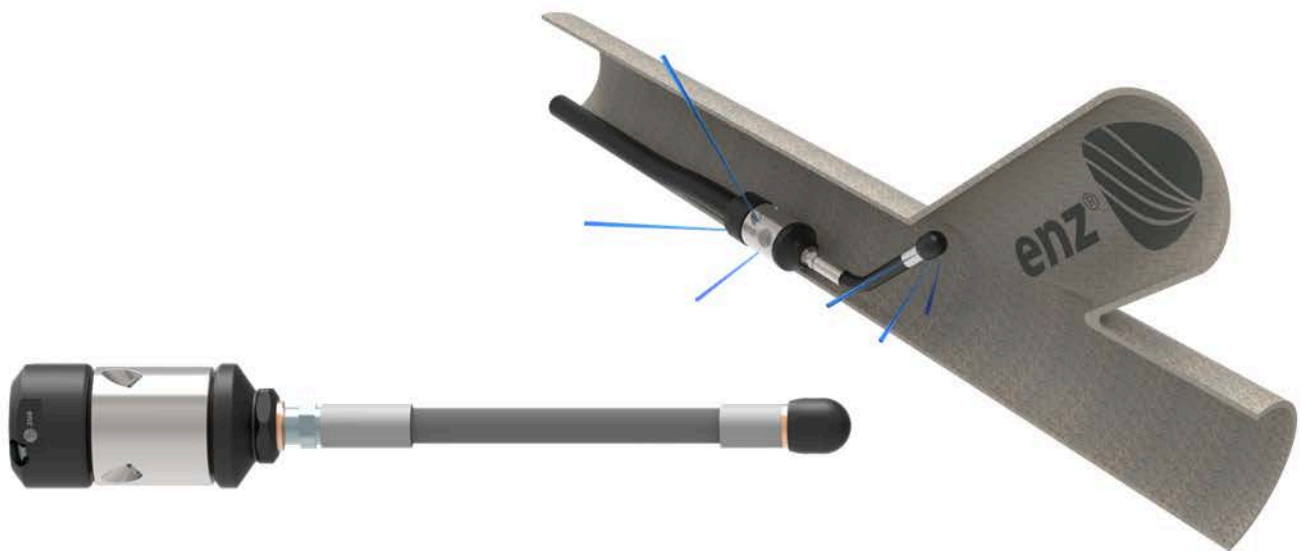

Guiding nozzles standard 1/2"



17.050-001	1/2"	2.4 - 5.9	13	6 x M8	1.89 x 10.51	2.09	5,000	

Guiding nozzle rotative 1/2"



17.040A-001	1/2"	3 - 6	11	4 x M6	3 x M6	1.7 x 10.4	1.46	5,000

Vibration guiding nozzle 1/2"



17.044AE-001	1/2"	3 - 6	11	4 x M4	3 x M6	1.7 x 11.5	1.54	5,000

Accessory and wearing parts guiding nozzles



95.001		Steering Set to 17.040A/44AE					0.25

Flounder

This enz® tool is especially suited to clean flat pipes and channels. The flat design combined with the rounded corners and edges provides the tool with ideal gliding properties. Ceramic inserts and an optimized flow reversal create compact and aggressive water jets. The low and compact design facilitates access to a wide variety of pipes and channels.





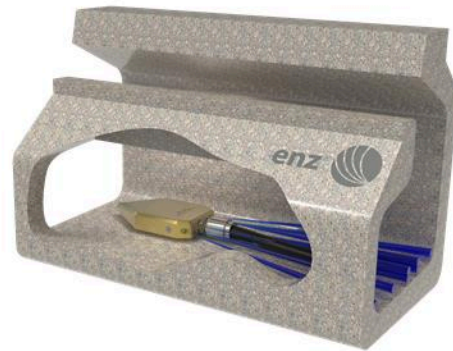



Applications

- Appropriate for removing mud and loose rubble in flat pipes and channels, e.g. run-off gutters



Flounder 1/2" - 1 1/4"



									
70.050	1/2"	6 - 10	16	S1: 2 x M8, S2: 2 x M8	S1: 15°, S2: 7.5°	7.7 x 3.5 x 1.4	5.73	ok	3,600
70.075	3/4"	8 - 16	26	S1: 2 x M8, S2: 4 x M8	S1: 15°, S2: 0°	7.7 x 3.9 x 2.0	7.06	ok	3,600
70.100	1"	12 - 24	53	S1: 2 x M10, S2: 2 x M10, S3: 4 x M10	S1: 15°, S2: 7.5°, S3: 0°	13.4 x 6.3 x 2.2	27.12	ok	3,600
70.125	1 1/4"	16 - 32	66	S1: 2 x M10, S2: 4 x M10, S3: 4 x M10	S1: 15°, S2: 7.5°, S3: 0°	15.0 x 7.4 x 2.8	41.89	ok	3,600

Ejector nozzles

These enz® tools are outstanding in their enormous flushing capacity. Their main application is cleaning large fully surcharged pipes and drains bigger than Ø 19 inch. The specific arrangement of the nozzle inserts ensures that cleaning is done carefully because the nozzle jets do not work directly against the pipe wall. As a result, this tool is also appropriate for cleaning older channel systems. It integrates the heavy water flow in pipes and channels into the flushing and cleaning process. In this way the water volume usable for cleaning is enhanced to five times the actual pump capacity. A pump of 80 gpm increase the flushing capacity of the nozzle to 400 gpm. As a result enormous quantities of sand and gravel can be removed fast and efficiently.





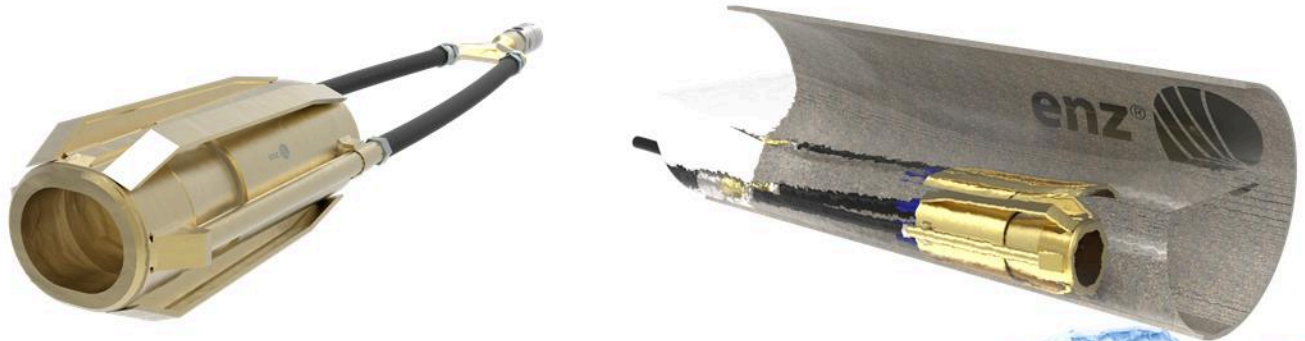



Applications

- For enormous flushing capacity













Ejector nozzles 1" - 1 1/4"



								 max
80.100	1"	8 - 20	53	6 x M6	11.8 x 6.3 x 4.7	16.31	ok	2,900
80.100A	1"	16 - 59	79	6 x M10	16.0 x 10.2 x 9.8	49.6	ok	2,900
80.125B	1 1/4"	24 - 79	79	10 x M10	18.9 x 11.8 x 9.8	68.34	ok	2,900
80.125D	1 1/4"	39 - 118	160	10 x M10	22.8 x 14.2 x 12.2	100.31	ok	2,900

Accessory and wearing parts Ejector nozzles



		
0080.100A02	 Y - Connection 1" - 2 x 3/4"	1" - 2 x 3/4" 1.01
0080.125B02	 Y - Connection 1 1/4" - 2 x 1"	1 1/4" - 2 x 1" 3.00
0080.10002	 Y - Connection 1" - 2 x 1/2"	1" - 2 x 1/2" 0.99
0080.12501	 Swivel Joint for 80.125B/D	1 1/4" 3.40
0080.10001	 Swivel Joint for 80.100/A	1" 2.09
0080.10003	 HP hose 1/2" - for 80.100	1/2" 4.19
0080.100A03	 HP hose 3/4" - for 80.100A	3/4" 4.19
0080.125B03	 HP hose 1" - for 80.100B/D	1" 4.19

enz®-Bulldozer

The scraper is used where particularly high flushing capacity and a correspondingly good flushing effect are required. Depending on the design, the tool is suitable for channel diameters between 200 and 2,500 mm. During this process, the scraper does not float. It thus ensures excellent basic cleaning even in channels that have a lot of water passing through them.

Area of application:

- Pipe diameter of 8" - 98.5"
- Cleaning large quantities of deposits
- Cleaning the bottom of a channel



enz®-Bulldozer 3/4" - 1 1/4"



50.075G	3/4"	12 - 20	26	4 x M10, 2 x FanJet M10	1 x M10	15.8 x 8.6 x 9.2	26.46	ok	3,600
50.100G	1"	16- 60	40	6 x M10, 2 x FanJet M10	1 x M10	20.1 x 10.8 x 10.6	56.22	ok	3,600
50.125G	1 1/4"	20 - 100	79	6 x M10, 2 x FanJet M10	1 x M10	25.5 x 12.6 x 11.8	82.67	ok	3,600

enz®-Bulldozer 1 1/2"







50.150	1 1/2"	20 - 177	106	8 x M10, 2 x FanJet M10	1 x M10	27.8 x 11.8 x 6.7	119.05	ok	3,600

Accessory and wearing parts enz®-Bulldozer



0050.15032		Skid for Scraper 1 1/2"	11.60		
0050.0753G		Skid for Scraper 3/4"	2.59		
0050.1003G		Skid for Scraper 1"	5.95		
0050.1253G		Skid for Bulldozer 1 1/4"	9.68		
50.10012G		Enlargement plate with screws for 50.100G	14.55		
0050.07510		Bulldozer flat skid 3/4"	13.01		
0050.10010G		Bulldozer flat skid 1"	14.33		
0050.12510G		Bulldozer flat skid 1 1/4"	29.98		
0050.1005G		Roll bar	16 - 59.1	11.7 x 10.8 x 9.1	6.20

					
0050.1255G		Roll bar	19.7 - 100	14.3 x 12.6 x 9.3	7.7
0050.0755G		Roll bar	11.9 - 19.7	9.1 x 8.7 x 7.7	5.3

Pendulum Nozzle

The enz® pendulum nozzle (oval profile bottom cleaner) cleans the bottom surface of large channels very well. This nozzle is especially suitable for the optimum cleaning and transport service in oval profiles. Thanks to the pendulum weight, a swivel joint that is offset from the middle, and water jets that are only directed downwards; stone deposits, debris and sludge can be removed effectively. Harder deposits can also be loosened and removed by using a special head with front jet. The heavy weight ensures that even with high water volumes, the nozzle does not fly up in the pipe. Thus, demonstrating its' cleaning performance.

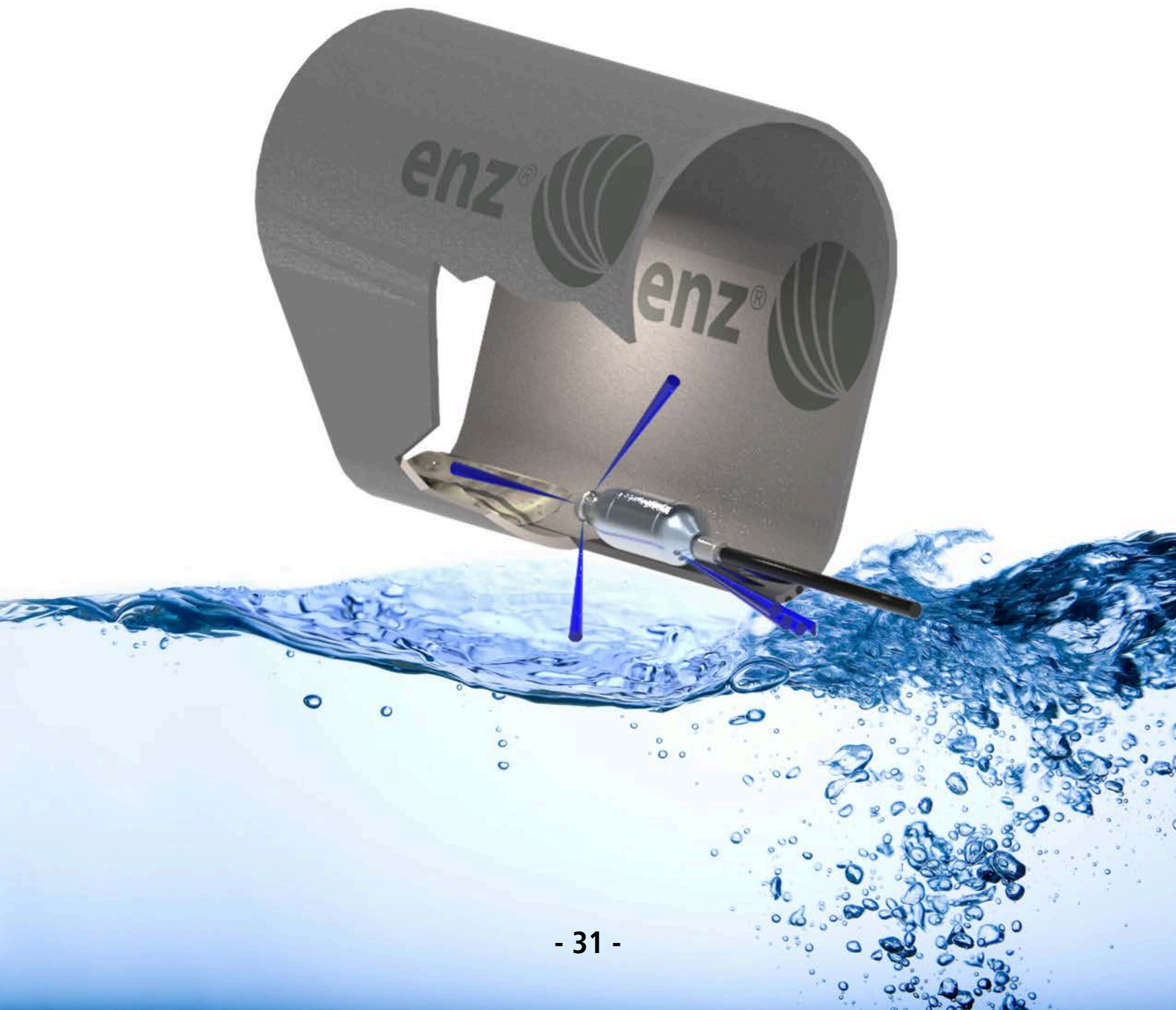

Pendulum Nozzle



Pendulum Nozzle



45.125B	1"	16 - 47	40	6.3 x 23	68	ok	2,900
45.125C	1 1/4"	16 - 47	40	6.3 x 23	68	ok	2,900

RGS nozzles

The radial rotating nozzles enz® are equipped with 4 radial jets of 75° for the pipe cleaning and 3 thrust jets for the advance which at the same time flush away the loosened residues. As a result, pipe ducts of all kinds, even with vertical borings etc., will be cleaned. The moving part of the enz® nozzle rotates at a limited speed. These water jets hit the pipe wall directly with great impact, striking every corner.









Applications

- Cleaning of drain pipes
- Cleaning of lateral pipes
- Removal of solid deposits



RGS nozzles



									
01.028N	1/4" NPT	2 - 4	5	4 x M4	3 x M4	*	1.1 x 2.2	0.44	5,000
01.040	1/2"	3 - 6	11	4 x M6	3 x M6	*	1.6 x 3.2	1.24	5,000
01.050A	1/2"	4 - 8	18	4 x M6	3 x M6	*	2.0 x 3.9	2.43	5,000
01.050B	3/4"	4 - 8	18	4 x M6	3 x M6	*	2.0 x 3.9	2.43	3,600
01.060	1"	4 - 12	26	4 x M8	3 x M8	*	2.4 x 4.4	3.53	3,600
01.100A	1"	8 - 24	53	4 x M10	3 x M10	*	2.9 x 7.1	16.31	3,600
01.100B	1 1/4"	8 - 24	53	4 x M10	3 x M10	*	3.9 x 7.1	16.31	3,600

HRH nozzles

The semi-radial rotating enz® nozzles with their 4 retroacting cutting-jets at an angle of approx. 45° cause simultaneously the cleaning procedure and the thrust for the forward move of the tool i.e. the jets combine rotation and thrust in one function resulting in a low water consumption. With sufficient water capacity, optional thrust jets can facilitate upward cleaning.





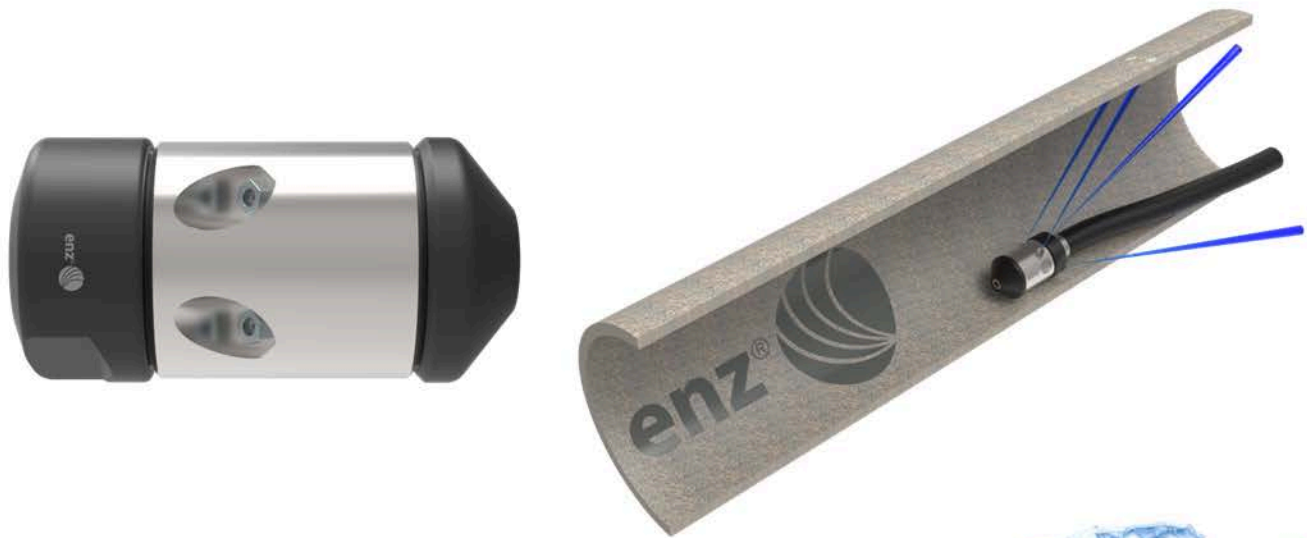



Applications

- Cleaning of pipes before TV-recordings
- To remove mineral deposits in pipes
- To remove roots up to Ø 5 mm











HRH nozzles 1/8" NPT - 1/4" NPT drilled



									
02.016A08N	1/8" NPT	1 - 2	3	2 x 0.8 - 2 x 0.7	-	*	0.6 x 1.2	0.07	5,000
02.016A13N	1/8" NPT	1 - 2	4	2 x 1.3 - 2 x 1.1	-	*	0.6 x 1.2	0.07	5,000
02.016B08N	1/4" NPT	1 - 2	3	2 x 0.8 - 2 x 0.7	-	*	0.6 x 1.2	0.07	5,000
02.016B13N	1/4" NPT	1 - 2	4	2 x 1.3 - 2 x 1.1	-	*	0.6 x 1.2	0.07	5,000









HRH nozzles 1/4" NPT - 3/4"



									
02.022BN	1/4" NPT	1 - 4	3	4 x M4	-	*	0.9 x 1.6	0.2	5,000
02.028AN	1/4" NPT	2 - 4	2	4 x M4	-	*	1.1 x 2.2	0.45	5,000
02.028ASN	1/4" NPT	2 - 4	3	4 x M4	3 x M4	*	1.1 x 2.2	0.45	5,000
02.028BN	3/8" NPT	2 - 4	2	4 x M4	-	*	1.1 x 2.2	0.45	5,000
02.040A	1/2"	3 - 6	4	4 x M6	-	*	1.6 x 3.2	1.24	5,000
02.040AS	1/2"	3 - 6	9	4 x M6	3 x M6	*	1.6 x 3.2	1.24	5,000
02.050A	1/2"	4 - 8	9	4 x M6	-	*	2.0 x 3.9	2.43	5,000
02.050AS	1/2"	4 - 8	9	4 x M6	3 x M6	*	2.0 x 3.9	2.43	5,000
02.050B	3/4"	4 - 8	8	4 x M6	-	*	2.0 x 3.9	2.43	3,600
02.050BS	3/4"	4 - 8	9	4 x M6	3 x M6	*	2.0 x 3.9	2.43	3,600

HRH nozzles 1" - 1 1/4"



									
02.060	1"	4 - 12	16	4 x M8	3 x M8	*	2.4 x 4.4	3.53	3,600
02.100A	1"	8 - 24	53	4 x M10	3 x M10	*	2.9 x 7.1	16.31	3,600
02.100B	1 1/4"	8 - 24	53	4 x M10	3 x M10	*	3.9 x 7.1	16.31	3,600

HRV nozzles

enz® nozzles with forward impact angle of approx. 45° on the pipe wall as well as a front jet (on request) and 3 retro-thrust jets cause a cork-screw-like advance through the clogged pipe. While the front nozzle loosens and the semi-radial nozzles disintegrate the residues, the thrust nozzles are driving the nozzle head forwards and simultaneously pushing the waste material backwards.





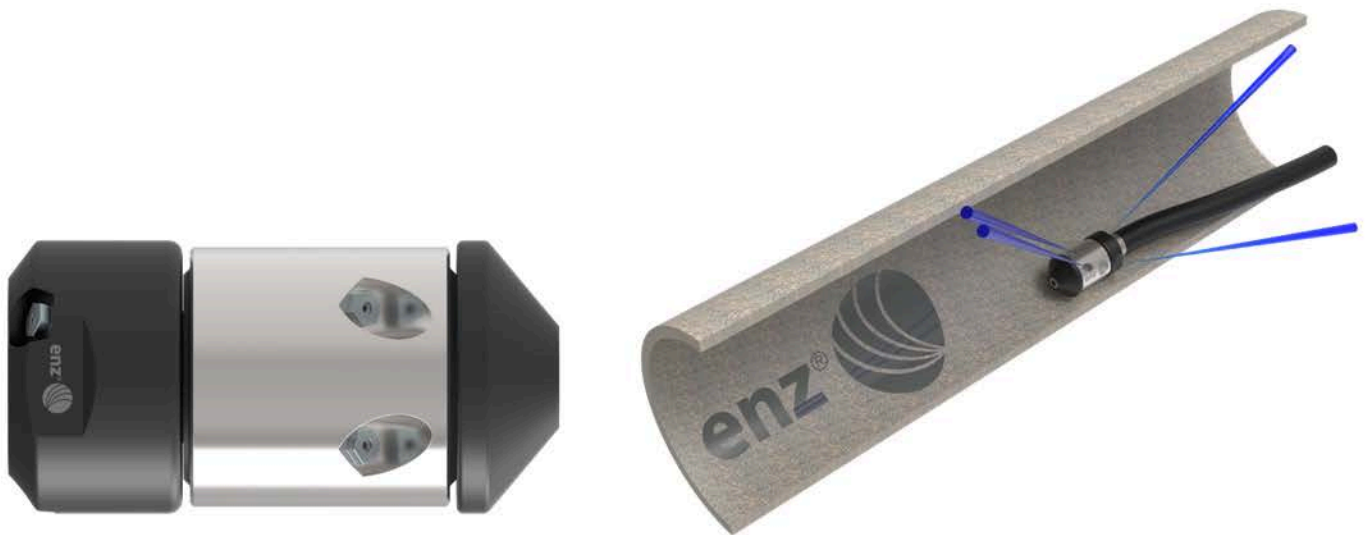



Applications

- Core-flushing of the steel pipes during hydraulic thrust-boring
- Cleaning of house connecting pipework from inside to the drain system
- Removal of ice in manholes



HRV nozzles 1/4" NPT - 1 1/4"



									
03.028N	1/4" NPT	2 - 4	8	4 x M4	3 x M4	*	1.1 x 2.2	0.45	5,000
03.040	1/2"	3 - 6	13	4 x M6	3 x M6	*	1.6 x 3.2	1.24	5,000
03.050A	1/2"	4 - 8	18	4 x M6	3 x M6	*	2.0 x 3.9	2.43	5,000
03.050B	3/4"	4 - 8	18	4 x M6	3 x M6	*	2.0 x 3.9	2.43	3,600
03.060	1"	4 - 12	26	4 x M8	3 x M8	*	2.4 x 4.4	3.53	3,600
03.100A	1"	8 - 24	53	4 x M10	3 x M10	*	3.9 x 7.1	16.31	3,600
03.100B	1 1/4"	8 - 24	53	4 x M10	3 x M10	*	3.9 x 7.1	16.31	3,600

KBR nozzles

This allround enz® combination nozzle is excellent for flushing out pipes as well as adjoining lateral pipes at any angle. It only requires a very small pump capacity and uses 2 radial jets at a 90° angle to the pipe wall and 2 semi-radial retro-jets at a 45° angle. This combination allows both, a forward thrust of the nozzle and simultaneously, a flushing away of the waste material.





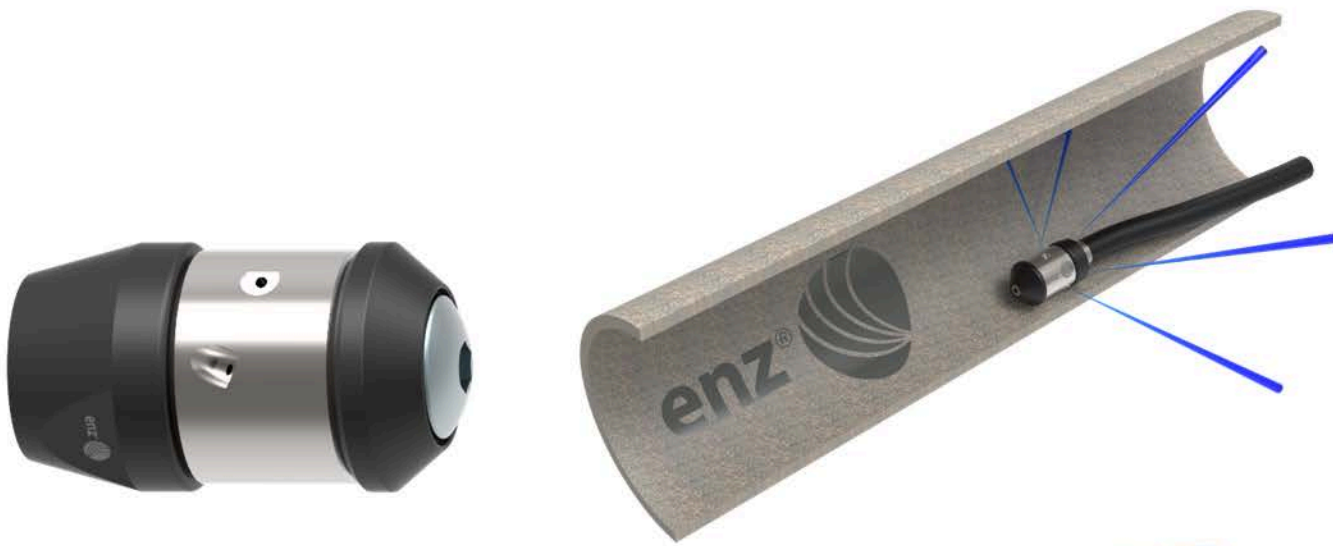



Applications

- To remove organic deposits
- To clean heat exchangers
- Cleaning of fat deposits











KBR nozzles 1/8" NPT drilled



								
04.012B05N	1/8" NPT	0.5 - 1	1.6	4 x 0.5		0.5 x 1.0	0.03	5,000
04.012B06N	1/8" NPT	0.5 - 1	1.8	4 x 0.6		0.5 x 1.0	0.03	5,000
04.012B07N	1/8" NPT	0.5 - 1	2.4	4 x 0.7		0.5 x 1.0	0.03	5,000
04.012B09N	1/8" NPT	0.5 - 1	3.2	4 x 0.9		0.5 x 1.0	0.03	5,000
04.012B12N	1/8" NPT	0.5 - 1	4.2	4 x 1.2		0.5 x 1.0	0.03	5,000
04.016A07N	1/8" NPT	1 - 2	3	4 x 0.7		0.6 x 1.2	0.07	5,000
04.016A08N	1/8" NPT	1 - 2	4	4 x 0.80		0.6 x 1.2	0.07	5,000
04.016A09N	1/8" NPT	1 - 2	4.5	4 x 0.90		0.6 x 1.2	0.07	5,000
04.016A10N	1/8" NPT	1 - 2	5.5	4 x 1.00		0.6 x 1.2	0.07	5,000
04.016A11N	1/8" NPT	1 - 2	7	4 x 1.10		0.6 x 1.2	0.07	5,000









KBR nozzles 1/4" NPT drilled



								
04.016B04N	1/4" NPT	1 - 2	1.5	4 x 0.40	-	0.6 x 1.2	0.07	5,000
04.016B07N	1/4" NPT	1 - 2	3	4 x 0.70	-	0.6 x 1.2	0.07	5,000
04.016B08N	1/4" NPT	1 - 2	3.5	4 x 0.80	-	0.6 x 1.2	0.07	5,000
04.016B09N	1/4" NPT	1 - 2	4.5	4 x 0.90	-	0.6 x 1.2	0.07	5,000
04.016B10N	1/4" NPT	1 - 2	5.5	4 x 1.00	-	0.6 x 1.2	0.07	5,000
04.016B11N	1/4" NPT	1 - 2	6.5	4 x 1.10	-	0.6 x 1.2	0.07	5,000
04.016BS07N	1/4" NPT	1 - 2	6	4 x 0.70	3 x 0.80	0.6 x 1.2	0.05	5,000
04.016BS08N	1/4" NPT	1 - 2	6	4 x 0.80	3 x 0.80	0.6 x 1.2	0.05	5,000









KBR nozzles 1/4" NPT



								
04.028AN	1/4" NPT	1 - 4	3	4 x M4	-	*	0.44	5,000
04.028ASN	1/4" NPT	1 - 4	3	4 x M4	3 x M4	*	0.44	5,000









KBR nozzles 3/8" NPT



									
04.028BN	3/8" NPT	1 - 4	3	4 x M4	-	*	1.1 x 2.2	0.20	5,000









KBR nozzles 1/2"



								
04.040A	1/2"	3 - 6	5	4 x M6	-	1.6 x 3.2	1.2	5,000
04.040AS	1/2"	3 - 6	11	4 x M6	3 x M6	1.6 x 3.2	1.2	5,000
04.050A	1/2"	4 - 8	18	4 x M6	-	2.0 x 3.9	2.4	5,000
04.050AS	1/2"	4 - 8	18	4 x M6	3 x M6	2.0 x 3.9	2.4	5,000









KBR nozzles 3/4"



								
04.050B	3/4"	4 - 8	18	4 x M6	-	2.0 x 3.9	2.4	3,600
04.050BS	3/4"	4 - 8	18	4 x M6	3 x M6	2.0 x 3.9	2.4	3,600

KBR nozzles 1" - 1 1/4"



								
04.060	1"	4 - 12	21	4 x M8	3 x M8	2.4 x 4.4	3.53	3,600
04.100A	1"	8 - 24	53	4 x M10	3 x M10	3.9 x 6.9	16.09	3,600
04.100B	1 1/4"	8 - 24	53	4 x M10	3 x M10	3.9 x 6.9	16.09	3,600

KBRV nozzles

The nozzle enz® KBRV is provided with 2 semi-radial jets directed forward in an angle of 45°. As a result, this nozzle must either be equipped with extra thrust jets or be mounted on a lance. The forward jets desintegrate most any residue and flush the debris ahead of the nozzle.









Applications

- To remove plastic deposits
- To clean heat exchangers
- Cleaning of fat deposits
- Flushing of the pipes from the house toward the main line











KBRV nozzles 1/8" - 1/4"



									 max
04.016AV07N	1/8" NPT	0.7 - 2.4	1.5	90°: 2 x 0.70, 45°: 2 x 0.70	-	*	0.6 x 1.2	0.06	5,000
04.016AV08N	1/8" NPT	0.7 - 2.4	3	90°: 2 x 0.80, 45°: 2 x 0.80	-	*	0.6 x 1.2	0.06	5,000
04.016AV09N	1/8" NPT	0.7 - 2.4	4	90°: 2 x 0.90, 45°: 2 x 0.90	-	*	0.6 x 1.2	0.06	5,000
04.016AV10N	1/8" NPT	0.7 - 2.4	4.5	90°: 2 x 1.00, 45°: 2 x 1.00	-	*	0.6 x 1.2	0.06	5,000
04.016AV11N	1/8" NPT	0.7 - 2.4	6.5	90°: 2 x 1.10, 45°: 2 x 1.10	-	*	0.6 x 1.2	0.06	5,000
04.016BV07N	1/4" NPT	0.7 - 2.4	1.5	90°: 2 x 0.70, 45°: 2 x 0.70	-	*	0.6 x 1.2	0.06	5,000
04.016BV08N	1/4" NPT	0.7 - 2.4	3	90°: 2 x 0.80, 45°: 2 x 0.80	-	*	0.6 x 1.2	0.06	5,000
04.016BV09N	1/4" NPT	0.7 - 2.4	4	90°: 2 x 0.90, 45°: 2 x 0.90	-	*	0.6 x 1.2	0.06	5,000
04.016BV10N	1/4" NPT	0.7 - 2.4	4.5	90°: 2 x 1.00, 45°: 2 x 1.00	-	*	0.6 x 1.2	0.06	5,000
04.016BV11N	1/4" NPT	0.7 - 2.4	6.5	90°: 2 x 1.10, 45°: 2 x 1.10	-	*	0.6 x 1.2	0.06	5,000

KBRV nozzles 1/4" - 1 1/4"



									 max
04.028AVN	1/4" NPT	1 - 4	5	90°: 2 x M4, 45°: 2 x M4	3 x M4	*	1.1 x 2.2	0.45	5,000
04.040AV	1/2"	3 - 6	8	90°: 2 x M6, 45°: 2 x M6	3 x M6	*	1.6 x 3.2	1.19	5,000
04.050AV	1/2"	4 - 8	18	90°: 2 x M6, 45°: 2 x M6	3 x M6	*	2.0 x 3.9	2.43	5,000
04.050BV	3/4"	4 - 8	18	90°: 2 x M6, 45°: 2 x M6	3 x M6	*	2.0 x 3.9	2.43	3,600
04.060V	1"	4 - 12	26	90°: 2 x M8, 45°: 2 x M8	3 x M8	*	2.4 x 4.4	3.53	3,600
04.100AV	1"	8 - 24	53	90°: 2 x M10, 45°: 2 x M10	3 x M10	*	3.9 x 6.9	16.09	3,600
04.100BV	1 1/4"	8 - 24	53	90°: 2 x M10, 45°: 2 x M10	3 x M10	*	3.9 x 6.9	16.09	3,600

Bulldog

The enz® Bulldog® rotating nozzle has been designed for operation with recycling water and fresh water. The cleverly built sliding bearing allows the use of every kind of recycled water. An integrated oil-free braking system results in a low wear and tear operation and in controlled numbers of rotation. In this way a most efficient and economic pipe cleaning is achieved. The bore of the nozzle insert determines the admissible size of the dirt particles up to a maximum Ø 1mm.

Characteristics

- Easy to handle
- The tool is practically maintenance-free

Applications

- To remove fat, roots and harder incrustations
- For operation with recycling water and fresh water

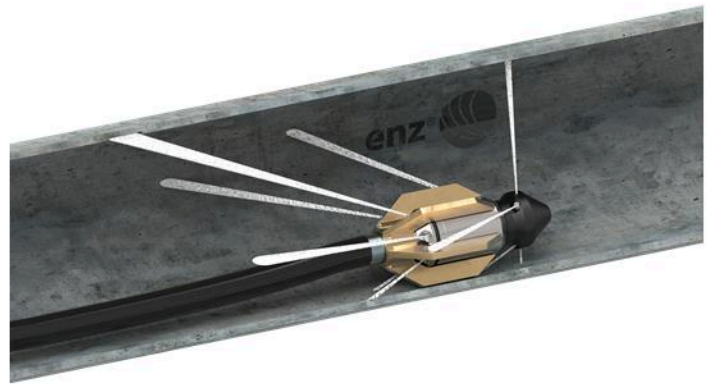



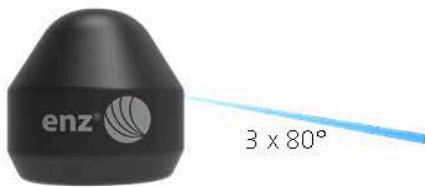







40x.037















40x.101















Bulldog® low flow 1/4" NPT - 1/2"

											
408.037	1/2"	1.6 - 4	6.5	50°: 2 x M6	-	1 x M6	165°	1.5 x 3.4	0.97	ok	5,000
408.037AN	1/4" NPT	1.6 - 4	6.5	50°: 2 x M6	-	1 x M6	170°	1.5 x 3.5	1.06	ok	5,000
408.037BN	3/8" NPT	1.6 - 4	6.5	50°: 2 x M6	-	1 x M6	170°	1.5 x 3.5	1.01	ok	5,000

Bulldog® 1/2" - 3/4"

												
400.037	1/2"	1.6 - 5	13	30°: 6 x M6	-	1 x M6		165°	1.5 x 3.4	0.93	ok	2,900
400.037S	1/2"	1.6 - 5	24	30°: 6 x M6	3 x M4	1 x M6	25°	165°	1.5 x 3.4	0.93	ok	2,900

Bulldog® with skid 1/2" - 3/4"

												
401.037	1/2"	3 - 8	11	80°: 3 x M6	-	-			2.4 x 4.8	1.59	ok	5,000
401.037CS	3/4"	3 - 8	16	80°: 3 x M6	3 x M4	-	25°		2.4 x 4.8	1.72	ok	5,000
401.037S	1/2"	3 - 8	16	80°: 3 x M6	3 x M4	-	25°		2.4 x 4.8	1.59	ok	5,000
404.037	1/2"	3 - 8	13	30°: 3 x M6, 80°: 3 x M6	-	-			2.4 x 4.8	1.59	ok	5,000
404.037CS	3/4"	3 - 8	21	30°: 3 x M6, 80°: 3 x M6	3 x M4	-	25°		2.4 x 4.8	1.72	ok	5,000
404.037S	1/2"	3 - 8	21	30°: 3 x M6, 80°: 3 x M6	3 x M4	-	25°		2.4 x 4.8	1.59	ok	5,000
406.037	1/2"	3 - 8	17	30°: 6 x M6	-	2 x M4		150°/165°	2.4 x 4.8	1.59	ok	5,000

406.037CS	3/4"	3 - 8	22	30°: 6 x M6	3 x M4	2 x M4	25°	150°/165°	2.4 x 4.8	1.72	ok	5,000
406.037S	1/2"	3 - 8	22	30°: 6 x M6	3 x M4	2 x M4	25°	150°/165°	2.4 x 4.8	1.59	ok	5,000

Accessory and wearing parts Bulldog 1/4" - 3/4"



00100.037101		Head Bulldog 1/2"	1.3 x 0.8	0.18		
00100.037107		Head Bulldog 1/2" 3x2	1.3 x 0.8	0.13		
00100.037104		Head KBR Bulldog 37	1.3 x 1.2	0.23		
00100.03720		Cage for Bulldog 37	1/2"	3 - 8	2.4 x 3.1	0.58
00100.03720B		Skid for Bulldog 37	3/4"	3 - 8	2.35 x 3.1	0.73

Bulldog® 3/4" - 1"



400.060A	3/4"	4 - 12	26	6 x M8	6 x M8	1 x M8	15°	2.4 x 6.0	4.63	ok	2,900
400.060B	1"	4 - 12	26	6 x M8	6 x M8	1 x M8	15°	2.4 x 6.0	4.63	ok	2,900
404.080HS100	1"	5 - 16	53	6 x M10	6 x M8	1 x M10	15°	3.9 x 8.7	8.16	ok	2,900
404.080HS150	1"	7 - 16	53	6 x M10	6 x M8	1 x M10	15°	5.9 x 10.2	12.72	ok	2,900

Accessory and wearing parts Bulldog 3/4" - 1"



							 max
100.060300P		Scissors skid with polyurethane wheels	3/4"	12 - 43	12 - 43 x 30	22.2	5,000
100.060300JP		Scissors skid with polyurethane wheels	3/4"	12 - 43	12 - 43 x 30	21.4	5,000
100.060300JS		Scissors skid with steel wheels + hand lever	3/4"	12 - 43	12 - 43 x 30	20.4	5,000
100.060300J		Scissors skid with hand lever	3/4"	12 - 43	12 - 43 x 30	18.8	5,000
100.060300S		Scissors skid with steel wheels	3/4"	12 - 43	12 - 43 x 30	21.2	5,000
100.060300		Scissors skid	3/4"	12 - 32	12 - 43 x 30	19.6	5,000
00100.0807		Skid guidance for Bulldog 80 / 60	1"	5 - 16	3.9 x 5.3	2.4	
00100.0808		Skid guidance for Bulldog 80/60	1"	7 - 16	5.9 x 7.1	6.3	
00400.0605		Head Bulldog 60			2.0 x 1.7	0.71	
00402.0805-4		Head HRH Bulldog 80			2.5 x 2.1	1.48	
00404.0805-12		Head KBR Bulldog 80			2.5 x 2.1	1.52	
00100.08073		Thrust stop with O-Ring and screw				0.09	

Bulldog® 1" - 1 1/4"



											 max
400.101A	1"	10 - 24	53	35°: 3 x M10, 90°: 2 x M10	6 x M10	1 x M10	15°	5.1 x 10.2	15.87	ok	2,900
400.101B	1 1/4"	10 - 24	53	35°: 3 x M10, 90°: 2 x M10	6 x M10	1 x M10	15°	5.1 x 10.2	15.87	ok	2,900

401.101AS	1"	10 - 24	53	80°: 6 x M10	6 x M10	1 x M10	15°	5.1 x 10.2	15.87	ok	2,900
401.101BS	1 1/4"	10 - 24	53	80°: 6 x M10	6 x M10	1 x M10	15°	5.1 x 10.2	15.87	ok	2,900
404.101AS	1"	10 - 24	53	80°: 3 x M10, 45°: 3 x M10	6 x M10	1 x M10	15°	5.1 x 10.2	15.87	ok	2,900
404.101BS	1 1/4"	10 - 24	53	80°: 3 x M10, 45°: 3 x M10	6 x M10	1 x M10	15°	5.1 x 10.2	15.87	ok	2,900

Accessory and wearing parts Bulldog 1" - 1 1/4"



00400.1014		Head KBR Bulldog 100	3.1 x 3.0	2.7		
00400.1015		Head RGS Bulldog 100	3.0 x 3.0	2.4		
100.1004RA		Cage 16'	1 1/4" m -> 1" f	16 - 39	15.0 x 22.8	22.05
100.1004RB		Cage 16''	1 1/4" m -> 1 1/4" f	16 - 39	15.0 x 22.8	22.05
100.1019A		BULLDOG Skids for cage 400.100 8''	1 1/4" - 1" f	10 - 31	7.9 x 11.4	11
100.1019B		BULLDOG Skids for cage 400.100	1 1/4" - 1 1/4" f	10 - 31	7.9 x 11.4	10.7
100.10073		Thrust stop with O-Ring and screw				
00100.1017B		Skid guidance 5/4'' Bulldog 100 mm	1" - 1 1/4"	8 - 23	6.5 x 5.3	5.0
00100.1017A		Skid guidance 1'' for Bulldog 100mm	1" - 1 1/4"	8 - 23	6.5 x 5.3	5.1

Bulldog® Antiblast

Cleaning sewer lines when near home installations brings the risk of pressure equalisation through toilets or stench traps. This comes from negative pressure arising ahead of the nozzle or excess pressure following the nozzle if the installation is not correct or venting is not working properly. It's a very unpleasant surprise when this effect unintentionally turns a toilet into a shower! For this reason, enz® collaborated with a prestigious technical institute to develop and test the Bulldog® Antiblast. The Bulldog® Antiblast prevents this unpleasant side effect and guarantees cleaning in all directions, right down to the pores.











Advantages

- No pressure equalisation through stench traps or toilets
- Excellent streak-free, all-around cleaning
- Low maintenance, and compatible with recycled water
- Proven design
- Very simple to match to pump capacity
- Scientifically examined and tested



Bulldog® Antiblast 1" - 1 1/4"



											
600.080	1"	8 - 16	48	6 x M10	6 x M8	1 x M10	15°	3.9 x 8.1	9.39	ok	2,900
600.100A	1"	10 - 24	53	6 x M10	6 x M10	1 x M10	15°	5.1 x 10.2	16.76	ok	2,900
600.100B	1 1/4"	10 - 24	53	6 x M10	6 x M10	1 x M10	15°	5.1 x 10.2	16.76	ok	2,900

Manhole nozzles

The enz® manhole nozzles are specifically designed for cleaning shafts and vertical pipes. The forward facing water jets provide circumferential cleaning without stripes. The nozzles are self-centering during operation and do not have protruding parts that can cause the nozzle to become wedged on the access ladder. They clean with a front jet on the floor as well and require little space in the cleaning vehicle. Additional advantages include the manhole nozzles having no water loss from leaks and require practically no maintenance. The arduous cleaning with a hand nozzle or a lance is history with the manhole nozzle. Likewise, conical shafts can be cleaned easily.

Advantages

- Circumferential cleaning of vertical pipes such as shafts or fountains
- Thorough cleaning even of very deep shafts



Manhole nozzles 1/2" - 3/4"



403.060A	1/2"	24 - 59	26	6 x M8	-	2 x M8	2.4 x 6.1	4.56	ok	2,900
403.060B	3/4"	24 - 59	26	6 x M8	-	2 x M8	2.4 x 6.1	4.56	ok	2,900

Manhole nozzles 1"



01.100LS	1"	24 - 59	26	4 x M10	-	*	3.9 x 7.0	16.09	3,600

Manhole nozzles 1" - 1 1/4"



401.101A	1"	10 - 79	40	6 x M10	-	1 x M10	15°	5.1 x 10.2	15.87	ok	2,900
401.101B	1 1/4"	10 - 79	40	6 x M10	-	1 x M10	15°	5.1 x 10.2	15.87	ok	2,900

Rotopuls vibration nozzles

The enz® rotating nozzle is provided with an eccentrically supported rotor, which produces very fast vibrations and pulsating jets. The resulting pulsations become as strong that deposits up to 10cm thickness are disintegrated. Thanks to the application of the rotopuls nozzle, the more expensive work with the cutting tools or with the chain flail head can be avoided in many cases.

Important: Rotopuls nozzles develop strong mechanical impacts and vibrations. This can possibly cause damage in some sort of pipes (e.g. earthenware pipes, thinwalled plastic pipes or badly-bedded PVC pipes).

Applications

- The Rotopuls nozzles are conceived to remove middle-hard deposits in pipes of plastic, steel or concrete

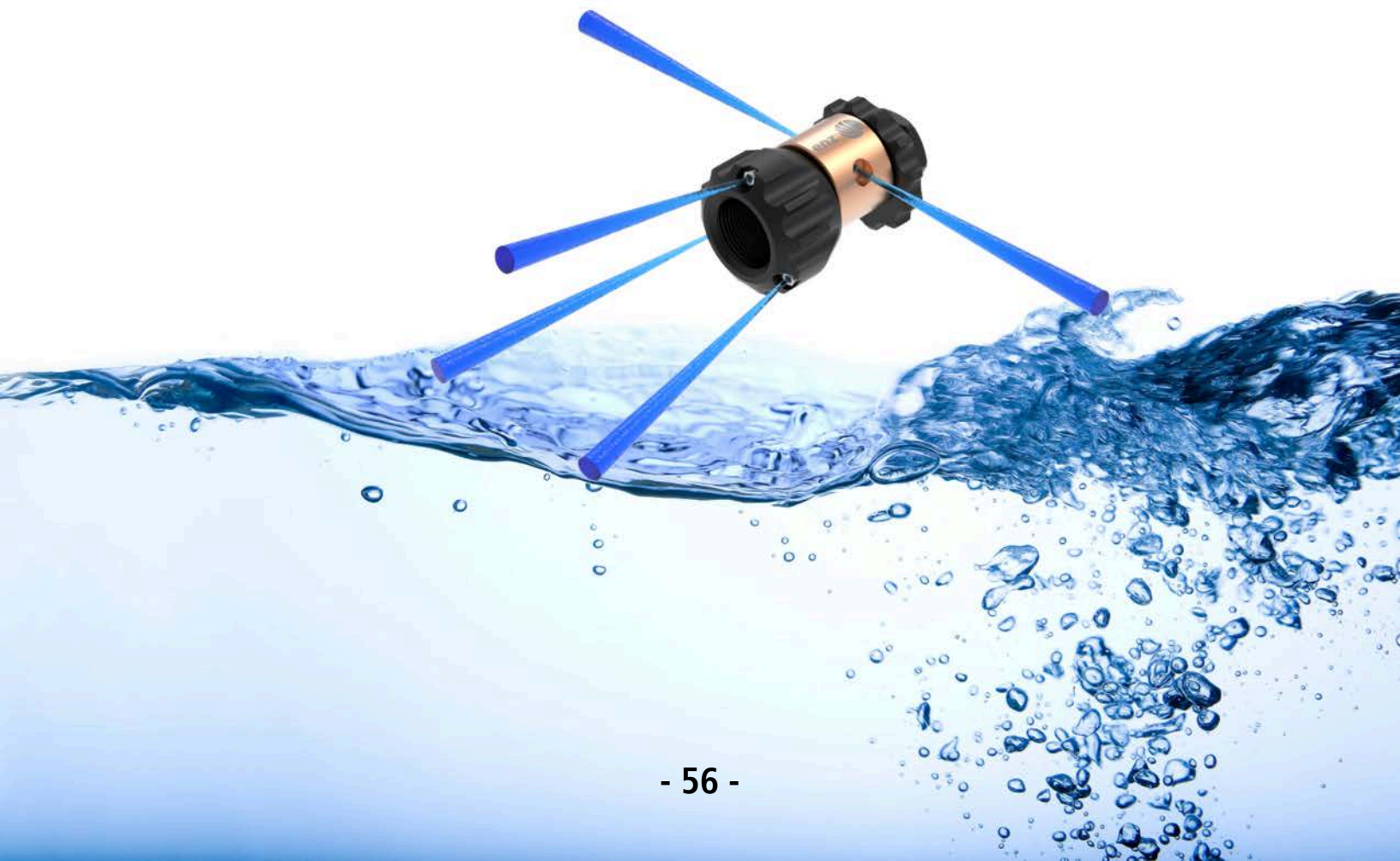

Rotopuls nozzles 1/8" NPT - 1/4" NPT



04.016ANE08	1/8" NPT	2 - 4	4	4 x 0.8	-	*	0.8 x 1.1	0.03	5,000
04.016ANE10	1/8" NPT	2 - 4	4	4 x 1.0	-	*	0.8 x 1.1	0.03	5,000
04.016ANES08	1/8" NPT	2 - 4	7	4 x 0.8	3 x 0.8	*	0.8 x 1.1	0.03	5,000
04.016ANES10	1/8" NPT	2 - 4	7	4 x 1.0	3 x 0.8	*	0.8 x 1.1	0.03	5,000
04.016BNE08	1/4" NPT	2 - 4	4	4 x 0.8	-	*	0.8 x 1.1	0.03	5,000
04.016BNE10	1/4" NPT	2 - 4	4	4 x 1.0	-	*	0.8 x 1.1	0.03	5,000
04.016BNES08	1/4" NPT	2 - 4	7	4 x 0.8	3 x 0.8	*	0.8 x 1.1	0.03	5,000
04.016BNES10	1/4" NPT	2 - 4	7	4 x 1.0	3 x 1.0	*	0.8 x 1.1	0.03	5,000

Rotopuls nozzles 1/4" NPT - 1 1/4"



01.028ANE	1/4" NPT	2 - 4	3	2 x M4	3 x M4	*	1.1 x 2.2	0.42	5,000
01.030ANE	1/4" NPT	2 - 4	3	2 x M4	3 x M4	-	1.2 x 2.0	0.33	5,000
02.028BNE	3/8" NPT	1 - 4	2	2 x M4	-	-	1.1 x 2.4	0.44	5,000
04.040AE	1/2"	3 - 6	5	4 x M4	3 x M6	*	1.6 x 3.2	1.16	5,000
04.050AE	1/2"	4 - 8	18	4 x M6	3 x M6	*	2.0 x 3.8	2.16	5,000
04.050BE	3/4"	4 - 8	18	4 x M6	3 x M6	*	2.0 x 3.8	2.16	3,600
04.060EK	1"	4 - 12	26	4 x M6	3 x M8	*	2.4 x 4.4	3.53	3,600
04.100BE	1 1/4"	8 - 24	53	4 x M10	3 x M10	*	3.9 x 6.9	15.87	3,600





Rotopuls nozzles 3/8" NPT - 1/2"



01.034ANE	3/8" NPT	1.8 - 6	5	2 x M4	3 x M4	*	1.3 x 2.3	0.49	5,000
01.034BE	1/2"	1.8 - 6	5	2 x M4	3 x M4	*	1.3 x 2.3	0.49	5,000
04.044AE	1/2"	3 - 6	5	4 x M4	3 x M6	*	1.7 x 3.6	1.32	5,000
04.044NE	3/8" NPT	3 - 6	5	4 x M4	3 x M6	*	1.7 x 3.6	1.32	5,000

Accessory and wearing parts Rotopuls



					
95.F100M075150	 HP Textile-Hose	3/4" m - 1" f		59.1	3.18
004.0444E	 Centre spire for ROTOPULS 04.0444E			0.5 x 1.2	0.04

Turbopuls vibration nozzles

The enz® Turbopuls nozzle is provided with an eccentrically supported rotor, which produces very fast vibrations and pulsating jets. The resulting pulsations become as strong that deposits up to 10cm thickness are disintegrated. Thanks to the application of the Turbopuls nozzle, the more expensive work with the cutting tools or with the chain flail head can be avoided in many cases.

Important: Turbopuls nozzles develop strong hydraulic impacts and vibrations. This can possibly cause damage in some sort of pipes (e.g. earthenware pipes, thinwalled plastic pipes or badly-bedded PVC pipes).

Applications

The Turbopuls nozzles are conceived to remove middle-hard deposits in pipes of plastic, steel or concrete



Turbopuls 1/2" - 3/4"



									max
410.060A	1/2"	4 - 8	16	1 x M6	3 x M8	2.5 x 7.1	5.29	ok	2,900
410.060B	3/4"	4 - 8	16	1 x M6	3 x M8	2.5 x 7.1	5.29	ok	2,900
410.080A	1/2"	6 - 12	21	1 x M6	3 x M8	3.1 x 8.3	9.48	ok	2,900
410.080A-G	1/2"	6 - 12	21	1 x M6	3 x M8	3.1 x 8.3	9.48	ok	2,900
410.080B	3/4"	6 - 12	21	1 x M6	3 x M8	3.1 x 8.3	9.48	ok	2,900
410.080B-G	3/4"	6 - 12	21	1 x M6	3 x M8	3.1 x 8.3	9.48	ok	2,900

Turbopuls 1" - 1 1/4"



									max
410.120A	1"	8 - 39	40	1 x M8	6 x M10	4.7 x 12.6	31.97	ok	2,900
410.120A-W	1"	8 - 39	40	1 x M8	6 x M10	4.7 x 12.6	31.97	ok	2,900
410.120B	1 1/4"	8 - 39	40	1 x M8	6 x M10	4.7 x 12.6	31.97	ok	2,900
410.120B-W	1 1/4"	8 - 39	40	1 x M8	6 x M10	4.7 x 12.6	31.97	ok	2,900











Accessory and wearing parts Turbopuls



						max
410.0805		Impact head standard			3.1 x 2.1	2.5
410.08052		Impact head 3.9" with screws			4.1 x 2.1	2.5
410.1205		Impact head standard with screws			4.72 x 2.75	5.22
410.12051		Impact head soft with screws			4.72 x 2.75	5.22

Turbopuls vibration nozzles



								 max
410.1209		Twinholder for 410.120	1" / 1 1/4"	from 16	2 x 39.63	14.2 x 27.6	15.43	2,900
00410.08010		Pointed center for Turbopuls Ø 80				0.6 x 2.4	0.15	
00410.12010		Pointed center for Turbopuls Ø 120mm				0.8 x 2.8	0.27	
95.F100M075150		HP Textile-Hose	3/4" m - 1" f			59.1	3.18	

Propeller nozzles

With this enz® tool large channels will be efficiently cleaned. They can be used for dimensions of Ø 600 - 3000 mm. The skirts are easy to adjust and can even be adapted to clean egg-shaped or oval pipe profiles. The propeller nozzles have been designed for the use of recycling-water, of course they can be used for fresh water as well.

Applications

- For cleaning large channels



Propeller nozzles 1" - 1 1/4"



07.2500A	1"	24 - 118	66	10 x M10	7 x M10	132	ok	2,900
07.2500B	1 1/4"	24 - 118	66	10 x M10	7 x M10	132	ok	2,900

Accessory and wearing parts propeller nozzles



007.281400		Extension tube					2.4	
------------	--	----------------	--	--	--	--	-----	--

Surface cleaner

Surface cleaner

The rotating enz® nozzle for cleaning surfaces is remarkable for its high efficiency. It outperforms conventional flat jet or round jet nozzles with a large margin.

Turbo Killer

This special nozzle for cleaning surfaces is rotated by the cleaning liquid by means of an impeller. The exhaust axis has an inclination against the central axis of the rotating nozzle, which results in a circular movement.

Applications

- Surface Cleaner: To remove deposits of concrete-slurry, cleaning of store fronts, steps, walls, traffic signboards etc.
- Turbo Killer: for the cleaning of steps, walls, artificial surfaces, traffic signs, etc.

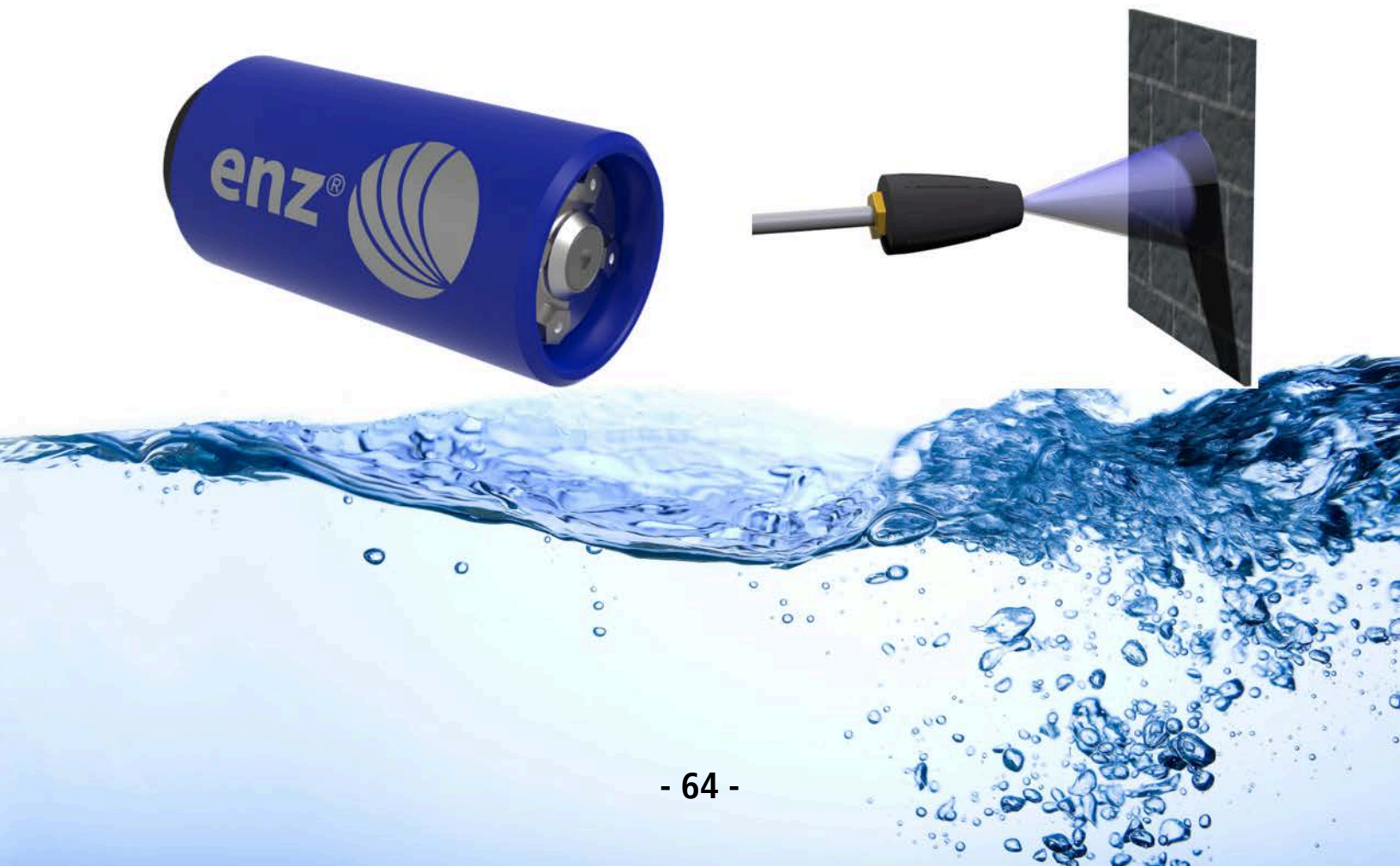

Surface cleaner 3/8" - 1/2"



18.040-C-0	1/2"	1.3	2 / 4 x M8	2.0 x 3.9	1.59	5,000
18.040-NB-0	3/8" NPT	1.3	2 / 4 x M8	2.0 x 4.2	1.59	5,000

Turbo killer 1/4"



18.020135	1/4"	3	1.35	20°	2.3 x 4.5	1.70	5,000
18.020150	1/4"	4	1.50	20°	2.3 x 4.5	1.70	5,000
18.020170	1/4"	5	1.70	20°	2.3 x 4.5	1.70	5,000
18.020190	1/4"	5	1.90	20°	2.3 x 4.5	1.70	5,000

Accessory and wearing parts Turbo killer



66.0106.20050	Rebuild kit for 18.041135	0.05
66.0106.20065	Rebuild kit for 18.041150	0.05
66.0106.20080	Rebuild kit for 18.041170	0.05
66.0106.20100	Rebuild kit for 18.041190	0.05

Rotodrill

The Rotodrill is a universal pipe cleaning nozzle suitable for pipe diameters between 2" and 10", depending on the design. Its special feature: Thanks to its cone-shaped rotating front jet, the Rotodrill mills through the clog in one operation. At the same time, most of the available water volume pushes the Rotodrill forward and transports the dirt out of the pipe. Customized repair kits allow for quick, easy maintenance.

In the Rotodrill REV (Reverse), the rotating jet is directed backwards. This allows deposits to be flushed efficiently out of the pipe. The pipe wall is cleaned at the same time.

Application:

Sludge deposits, fine roots, clogs, and maintenance cleaning.

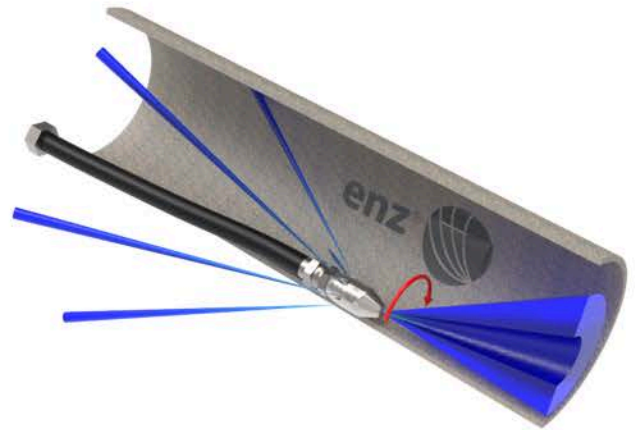

Rotodrill 1/8" NPT - 1/4" NPT



36.025ANS	1/8" NPT	1.6 - 4	4.8	3 x 1.0	1 x 0.90	7°	12°	1.5 x 0.9	0.1	5,000
36.025BNS	1/4" NPT	1.6 - 4	4.8	3 x 1.0	1 x 0.90	7°	12°	1.5 x 0.9	0.1	5,000

Rotodrill 1/4" NPT - 3/8" NPT



36.025NiREV	1/4" NPT	3 - 6	4	1 x 1.50	-	25°	-	2.7 x 4.1	0.57	5,000
36.038NiREV	3/8" NPT	3 - 6	4	1 x 1.50	-	25°	-	2.7 x 4.1	0.57	5,000

Rotodrill 3/8" NPT - 1"







36.038N	3/8" NPT	2 - 6	6.6	6 x M4	1 x 0.90 - 1.80	15°	7°	1.3 x 2.6	0.66	5,000
36.050	1/2"	2 - 6	6.6	6 x M4	1 x 0.90 - 1.80	15°	7°	1.3 x 2.4	0.44	5,000
36.075	3/4"	3 - 8	20	6 x M6	1 x 0.90 - 1.80	30°	7°	1.5 x 3.0	0.75	5,000
36.100	1"	4 - 10	27	6 x M8	1 x 2.70	25°	7°	2.2 x 3.7	1.91	3,600

Accessory and wearing parts Rotodrill



66.21040-020	Re-build kit for Rotodrill 36.0xx Ø 0.90	0.06

				
66.21040-040		Re-build kit for Rotodrill 36.0xx	Ø 1.20	0.06
66.21040-060		Re-build kit for Rotodrill 36.0xx	Ø 1.50	0.06
66.21040-080		Re-build kit for Rotodrill 36.0xx	Ø 1.80	0.06
66.21060-200		Re-build kit for Rotodrill 36.100	Ø 2.70	0.11

HydroX









The HydroX has a powerful rotating front jet. However, it manages without thrust nozzles. This tool is designed for efficient hydraulic excavation with low water consumption – for working with a lance outside pipes. During operation, a rotating 18° water cone is created, which acts like a drill in the ground. A plastic sheath prevents any flying sparks. Customized repair kits allow for simple, fast maintenance.

Application:
Hydraulic excavation, surface cleaning.





HydroX 3/8" NPT - 1/2"



								
36.038HE235N	3/8" NPT	7	-	2.35	7°	1.3 x 2.2	0.57	5,000
36.050HE235	1/2"	7	-	2.35	7°	1.3 x 2.2	0.57	5,000







Accessory HydroX



		
66.21040HE-235  Re-build kit for HydroX	Ø 2.35mm	0.06

MJ4



							
550.04001	3/8" BSPP	1.45	0.6 - 2.8	22°	1.7 x 4.3	1.10	7,500
550.04002	3/8" NPT	1.45	0.6 - 2.8	22°	1.7 x 4.3	1.10	7,500
550.04003	1/2" BSPP	1.45	0.6 - 2.8	22°	1.7 x 4.3	1.10	7,500
550.04004	1/2" NPT	1.45	0.6 - 2.8	22°	1.7 x 4.3	1.10	7,500
550.04005	1/4" BSPP	1.45	0.6 - 2.8	22°	1.7 x 4.3	1.10	7,500
550.04011	9/16" x 18 UNF LH	1.45	0.6 - 2.8	22°	1.7 x 4.3	1.10	7,500
550.04012	M14 x 1.5 LH	1.45	0.6 - 2.8	22°	1.7 x 4.3	1.10	7,500
550.04015	M26 x 1.5	1.45	0.6 - 2.8	22°	1.7 x 4.3	1.10	7,500

Wire rope and chain scrapers

The Chain scraper enz® is an apparatus which has many uses and is simple in handling and maintenance. Several different pipe diameters can be cleaned with the same tool. Layers of mineral deposits and concrete residues are efficiently removed.

Applications

- As preliminary operation before renovation with liners, coatings or by injections
- Complete root removal
- Removal of incrustations and deposits
- Removal of concrete residues in newly installed sewage pipelines prior to inspection

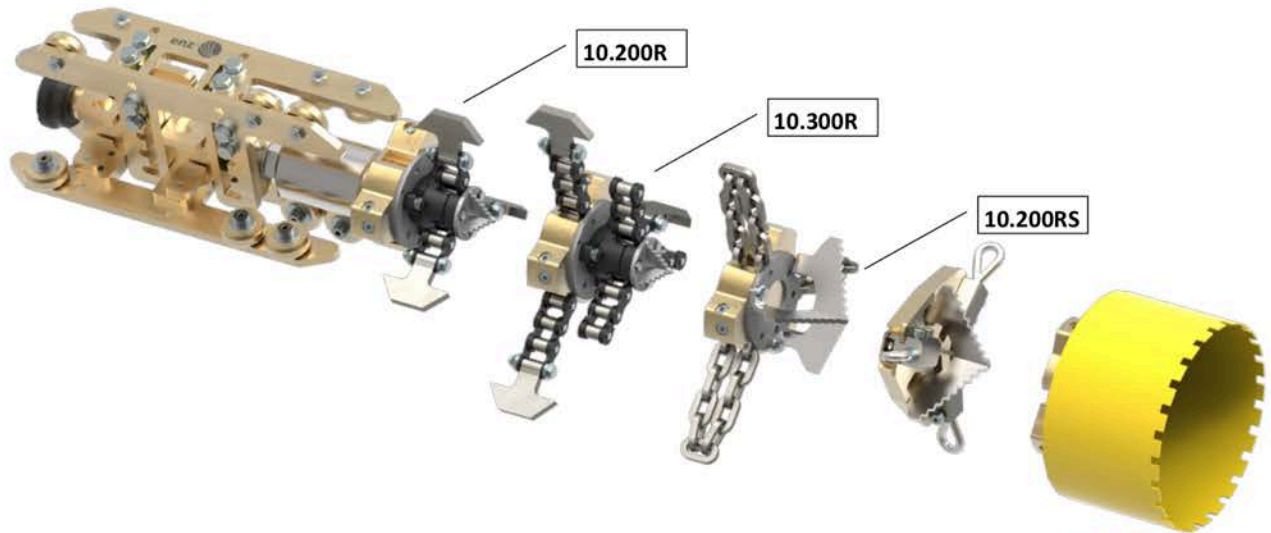

Chain scraper 10.028 1/4" NPT



10.028N	1/4" NPT	2 - 4	5	3 x M4	3 x M4	1.6 / 1.1 x 3.1	2.0		5,000

Chain scrapers 10.060TR 3/8" NPT - 3/4" NPT



10.060ATR-US	3/8" NPT	2.4 - 8	8	2 x M6	4 x M6	1.6 x 4.4	2.10	ok	5,000
10.060BTR-US	1/2"	2.4 - 8	8	2 x M6	4 x M6	1.6 x 4.4	2.10	ok	5,000
10.060CTR-US	3/4"	2.4 - 8	8	2 x M6	4 x M6	1.6 x 5.3	2.35	ok	3,600

Chain scrapers 10.061A/B 1/2" - 3/4"



10.061A	1/2"	3 - 7.8	16	3 x M6	3 x M6	2.4 x 5.3	3.09		3,600
10.061B	3/4"	3 - 7.8	16	3 x M6	3 x M6	2.4 x 5.3	3.09		3,600

Chain scrapers 10.125TR 1"



10.125TR									
10.125TR-100	1"	4	13	2 x M6	4 x M8	2.4 x 6	5.51	ok	3,600
10.125TR-125	1"	5	13	2 x M6	4 x M8	2.4 x 6	5.51	ok	3,600
10.125TR-150	1"	6	13	2 x M6	4 x M8	2.4 x 6	5.51	ok	3,600
10.125TR-200	1"	8	13	2 x M6	4 x M8	2.4 x 6	5.51	ok	3,600

10.125TR-225	1"	9	13	2 x M6	4 x M8	2.4 x 6	5.51	ok	3,600
10.125TR-250	1"	10	13	2 x M6	4 x M8	2.4 x 6	5.51	ok	3,600
10.125TR-300	1"	12	13	2 x M6	4 x M8	2.4 x 6	5.51	ok	3,600

Chain scrapers 10.125TR 1" US



10.125TR-150-US	1"	2 x M6	4 x M8	2.4 x 6	5.56	ok
10.125TR-200-US	1"	2 x M6	4 x M8	2.4 x 6	5.56	ok
10.125TR-250-US	1"	2 x M6	4 x M8	2.4 x 6	5.56	ok
10.125TR-US	1"	1 x M6	4 x M8	2.4 x 6	5.56	ok

Chain scrapers 10.150RL 1"



10.150RL	1"	6 - 10	26	3 x M8	3 x M10	5.3 - 9.3 x 19.7	28.88	ok	2,900

Wire rope and chain scrapers sets



10.060BTR-SET-US	chain flail 2.36 - 6"	1/2"	3.8
10.060ATR-SET-US	chain flail 2.36 - 6"	3/8"	3.8
10.060CTR-SET-US	chain flail 2.36 - 6"	3/4"	3.8

10.125TR-SET-US		TurboJet rotating chain scraper 2.4"	1"	16.76
10.060BTR-SET-CH		chain flail 2.36 - 6"	1/2"	6.4
10.060CTR-SET-CH		chain flail 2.36 - 6"	3/4"	6.83
10.060BTR-GS		chain flail 2.36 - 6"	1/2"	5.07
10.060ATR-GS		chain flail 2.36 - 6"	3/8"	5.07
10.060CTR-GS		chain flail 2.36 - 6"	3/4"	5.07
10.125TR-GS		TurboJet rotating chain scraper	1"	15.87
10.125TR-100-GS		TurboJet rotating chain scraper 2.4"	1"	16.76

Wire rope and chain scrapers 10.200R/RS



10.200R	1"	7.8 - 16	53	3 x M10	3 x M10	7.3 - 15.2 x 22.1	77.16	ok	2,900
10.200RS	1"	7.8 - 16	53	3 x M10	3 x M10	7.3 - 15.2 x 22.0	77.16	ok	2,900









Wire rope and chain scrapers 10.300R 1"



10.300R	1"	7.8 - 19.7	53	3 x M10	3 x M10	7.3 - 19.2 x 22.1	108	ok	2,900









Wire rope and chain scrapers 10.400R/RS 1"



									 max
10.400R	1"	16 - 32	79	3 x M10	3 x M10	15.2 - 30.9 x 24.6	103.62	ok	2,900
10.400RS	1"	16 - 32	79	3 x M10	3 x M10	15.2 - 30.9 x 24.6	104.44	ok	2'900

Chain scrapers 10.800R 1 1/4"





									 max
10.800R	1 1/4"	32 - 47	106	3 x M10	6 x M10	22.1 / 30.4 x 64.6	407.86	ok	2,900

Wire rope and chain scrapers



Accessory 10.028



10.028

	Pipe diameter	Ø 2 "	Ø 3 "	Ø 4 "	Ø per yard
	Pin bolt chain Ø 1.9 inch	0010.028050G	0010.028075G	0010.028100G	0010.028G
	Chaîne à maillons Ø 2 inch	0010.028050K	0010.028075K	0010.028100K	0010.028K
	Cover with cutter	0010.0285M	0010.0285M	0010.0285M	
	Plastic guide	0010.0286	0010.0286	0010.0286	





Accessories 10.060

10.060ATR

	Pipe diameter	Ø 2 "	Ø 3 "	Ø 4 "	Ø 5 "	Ø 6 "	Ø 8 "	per yard
	Set Pin bolt chain with plates Ø 2.4 inch	0010.060060G	0010.060075G	0010.060100G	0010.060125G	0010.060150G	0010.060200G	11.G
	Set link chains Ø 2.4 inch	0010.040060K	0010.040075K	0010.040100K	0010.040125K	0010.040150K	0010.040200K	0010.040K
	Cover with cutter and screws	0010.0605TRM	0010.0605TRM	0010.0605TRM	0010.0605TRM	0010.0605TRM	0010.0605TRM	

Wire rope and chain scrapers



Pipe diameter	Ø 2 "	Ø 3 "	Ø 4 "	Ø 5 "	Ø 6 "	Ø 8 "	per yard
 Cage for Turbojet 60	0010.0607TR	0010.0607TR	0010.0607TR	0010.0607TR	0010.0607TR	0010.0607TR	
 Skid Turbojet 60			0010.060710TR	0010.060712TR	0010.060715TR	0010.060720TR	



Accessoires 10.061A/B



10.061A

Pipe diameter	Ø 3 "	Ø 4 "	Ø 6 "	Ø 8 "	per yard
 Set chains 0.18" - 7 links	11.07	11.09	11.11	11.13	11
 Bronze-bushing for 10.061A/B					







Accessories 10.125TR

10.125TR

Pipe diameter	Ø 5 "	Ø 6 "	Ø 8 "	Ø 9 "	Ø 10 "	Ø 12 "	per yard
 Set Pin bolt chain with plates	0010.125125G	0010.125150G	0010.125200G	0010.125225G	0010.125250G	0010.125300G	0010.125G
 Set link chains	0010.125125K	0010.125150K	0010.125200K	0010.125225K	0010.125250K	0010.125300K	11

Wire rope and chain scrapers







	Pipe diameter	Ø 5 "	Ø 6 "	Ø 8 "	Ø 9 "	Ø 10 "	Ø 12 "	per yard
	Set wire brushes		0010.125150SE	0010.125200SE		0010.125250SE		
	Cover with cutter	0010.1254TR	0010.1254TR	0010.1254TR	0010.1254TR	0010.1254TR	0010.1254TR	
	Cage for 10.125TR	0010.1257TR	0010.1257TR	0010.1257TR	0010.1257TR	0010.1257TR	0010.1257TR	
	Skid for	0010.125712TR	0010.125715TR	0010.125720TR	0010.125722TR	0010.125725TR	0010.125730TR	



Accessories 10.150RL

10.150RL











	Pipe diameter	Ø 6 "	Ø 8 "	Ø 10 "	per yard
	Set Pin bolt chain	0010.150150G	0010.150200G	0010.150250G	0010.150G
	Set chains	0010.150150K	0010.150200K		11.B
	Set Chain plates	0010.1508R	0010.1508R	0010.1508R	
	Skids Chain Flail 150 - 250	0010.1502R	0010.1502R	0010.1502R	
	Diamond crown	0010.150D	0010.200D	0010.250D	

Wire rope and chain scrapers









Accessories 10.200R/RS & 10.300R

10.200R

	Pipe diameter	Ø 8 "	Ø 10 "	Ø 12 "	Ø 14 "	Ø 16 "	Ø 20 "	per yard
	Set Pin bolt chain with plate	12.200G	12.250G	12.300G	12.350G	12.401G	12.600G	12.G
	Set chains	12.03	12.07	12.09	12.11	12.13	12.17	12
	Pull part 10.200R/10.400R	0010.2006	0010.2006	0010.2006	0010.2006	0010.2006	0010.2006	
	Set Chain plates	0010.2008R	0010.2008R	0010.2008R	0010.2008R	0010.2008R	0010.2008R	
	Center head with 4 link chain	0010.2004R	0010.2004R	0010.2004R	0010.2004R	0010.2004R		
	Wire rope head adaption kit	0010.2005	0010.2005	0010.2005	0010.2005	0010.2005		
	Set of wire rope loop	12.200S	12.250S	12.300S	12.350S	12.400S		
	Set of wire rope brush	12.200SE	12.250SE	12.300SE	12.350SE	12.400SE		
	Diamond crown	0010.200D	0010.250D	0010.300D				
	Skid Front Chain Bulldozer	0010.20071R	0010.20071R	0010.20071R	0010.20071R	0010.20071R		
	Skid back Chain Bulldozer	0010.20072R	0010.20072R	0010.20072R	0010.20072R	0010.20072R		

Wire rope and chain scrapers



	Pipe diameter	Ø 8 "	Ø 10 "	Ø 12 "	Ø 14 "	Ø 16 "	Ø 20 "	per yard
	Cover with cutter	0010.1254TR	0010.1254TR	0010.1254TR	0010.1254TR	0010.1254TR	0010.1254TR	
	Root knife chain flail 10.200RS	0010.2509	0010.2509	0010.2509	0010.2509	0010.2509		
	Center head with 4 link chain	0010.2004R1	0010.2004R1	0010.2004R1	0010.2004R1	0010.2004R1		
	Skid adapter 19.7"			10.2005R	10.2005R	10.2005R	10.2005R	
	Head 300R with chain	0010.2005R	0010.2005R	0010.2005R	0010.2005R	0010.2005R	0010.2005R	
	Head 200RS with chain	0010.2006R	0010.2006R	0010.2006R	0010.2006R	0010.2006R		
	Set chains with 3 links and plates	12.03P	12.07P	12.09P	12.11P	12.13P		



Accessories 10.400R/RS

10.400R

	Pipe diameter	Ø 16 "	Ø 18 "	Ø 20 "	Ø 22 "	Ø 24 "	Ø 26 "	Ø 28 "	Ø 30 "	Ø 32 "	per yard
	Set Pin bolt chain with plate	12.402G	12.450G	12.500G	12.600G	12.600G	12.700G	12.700G	12.800G	12.800G	12.G

Wire rope and chain scrapers



	Pipe diameter	Ø 16 "	Ø 18 "	Ø 20 "	Ø 22 "	Ø 24 "	Ø 26 "	Ø 28 "	Ø 30 "	Ø 32 "	per yard
	Chain (Set 3 x 4") for center head of 10.400R	12.400ZG	12.400ZG	12.400ZG	12.400ZG	12.400ZG	12.400ZG	12.400ZG	12.400ZG	12.400ZG	
	Set chains	12.07	12.09	12.11	12.13		12.17				12
	Pull part 10.200R/10.400R	0010.2006	0010.2006	0010.2006	0010.2006	0010.2006	0010.2006	0010.2006	0010.2006	0010.2006	
	Center head (all Ø)	0010.4004R	0010.4004R	0010.4004R	0010.4004R	0010.4004R	0010.4004R	0010.4004R	0010.4004R	0010.4004R	
	Wire rope head	0010.4005	0010.4005	0010.4005	0010.4005	0010.4005					
	Wire rope loop (1 set)	12.250S	12.300S	12.350S	12.400S	12.600S		12.700S			
	Set of wire rope brush 9.8"	12.250SE	12.300SE	12.350SE	12.400SE						
	Egg Skid's complete 23.6" - 35.4"	10.4008R	10.4008R	10.4008R	10.4008R	10.4008R	10.4008R	10.4008R	10.4008R	10.4008R	
	Root knife chain Bulldozer	0010.3804	0010.3804	0010.3804	0010.3804	0010.3804	0010.3804	0010.3804	0010.3804	0010.3804	
	Cover with cutter	0010.1254TR	0010.1254TR	0010.1254TR	0010.1254TR	0010.1254TR	0010.1254TR	0010.1254TR	0010.1254TR	0010.1254TR	
	Set chains with 7 links and plates	12.07P	12.09P	12.11P		12.15P		12.19P			

Wire rope and chain scrapers



Milling cutters without impacts

These enz® rotating cutters work without impacts. The cutter heads are equipped with hard metal plates, which are able to remove the most any kind of deposits. Their field of application is versatile. Layers of mineral deposits, concrete or concrete sludges can be milled out with them as well as roots and wood.

Applications

- Concrete or concrete sludges
- Layers of mineral deposits
- Roots, wood



Cutters without impacts 1/4"



13.028N	1/4" NPT	1.2	5	3 x M4	3 x M4	1.1 x 3.2	0.6	5,000	

Cutters without impacts 1/2" - 1"









13.040TR	1/2"	1.7 - 2.4	8	2 x M6	4 x M6	-	1.6 x 4.3	1.65	ok	3,600
13.060TR	1"	2.4 - 3.1	13	2 x M6	4 x M8	-	2.4 x 5.1	4.40	ok	3,600

Accessory and wearing parts cutters without impacts



0013.0605TR		Milling Cutter Head 2.4"								1.43
0013.0405TR		Milling Cutter Head complete for 1.6"								0.66
0013.0404TR-48		Wear resistant ring for Milling Cutter 40 mm								0.15
0013.0407TR-48		Wear ring for Milling Cutter 40 mm								0.23
0013.0604TR-68		Wear resistant ring								0.28
0013.0607TR-68		Wear ring for Milling Cutter 60mm								0.28

			
16.16Z		Carbide Insert with Screw for 13.040TR	0.06
16.19Z		Carbide Insert with Screw for 13.060TR	0.06
0013.0606TR		exchangeble centre for Ø60 Cutter	0.022
FS242		Insert-Clamp-Screw for 16.16ZW	
FS1010		Insert-Clamp-Screw for 16.19ZW	
C20			

Cutting ball

The CB range (enz® cutting ball) is equipped with a carbide root knife or penetrator blade for pipes that are clogged by more than 50%. The CB90 and CB70 (enz cutting ball) work without impact, but are equipped with a plug that can be removed, that creates a vibration in the tool when rotating. (not the CB50). The cutters on the side are self-sharpening and maintain their sharpness over their entire service life. The area of application of the cutting ball is diverse. Due to its spherical shape it can easily navigate bends without damaging the pipe. Moreover, the proven braking system from enz® ensures for a lower rotation speed. The CB90 + CB70 are leakage-free and can be operated with recycling water.

- The enz® CB cutting balls are particularly suitable for roots in seepage pipes, mineral deposits and limescale.
- All CB cutting balls are supplied in an enz® case.



CB50 1/4" -1/2"



420.050AN	1/4" NPT	2.2 x 4.0	6.6	4 x M6	-	1.9 x 2.4	0.9	2,900	
420.050BN	3/8" NPT	2.2 x 4.0	6.6	4 x M6	-	1.9 x 2.4	0.9	2,900	
420.050BSN	3/8" NPT	2.2 - 4.0	14.5	4 x M6	4x Ø 1.3mm	1.9 x 2.4	0.9	2,900	
420.050C	BSPP 1/2"	2.2 x 4.0	6.6	4 x M6	-	1.9 x 2.3	0.9	2,900	
420.050CS	BSPP 1/2"	2.2 - 4.0	14.5	4 x M6	4x Ø 1.3mm	1.9 x 2.3	0.9	2,900	

CB70 1/2"



420.070A	1/2"	3 - 5	15	6 x M6	-	2.67 x 3.6	2.43	ok	2,900
420.070AS	1/2"	3 - 5	21	6 x M6	3 x M4	2.67 x 3.6	2.43	ok	2,900

CB70 1/2" CC



425.070A	1/2"	3 - 5	15	6 x M6	-	2.67 x 3.6	2.43	ok	2,900
425.070AS	1/2"	3 - 5	15	6 x M6	3 x M4	2.67 x 3.6	2.43	ok	2,900

CB90 1/2"



420.090A	1/2"	4 - 6	16	6 x M6	-	3.5 x 3.8	4.94	ok	2,900
420.090AS	1/2"	4 - 6	21	6 x M6	3 x M4	3.5 x 3.8	4.94	ok	2,900

Cutting ball



CB90 1/2" CC



	1/2"	4 - 6	16	6 x M6	-	*	3.5 x 3.8	4.94	ok	max
425.090A	1/2"	4 - 6	16	6 x M6	-	*	3.5 x 3.8	4.94	ok	2,900
425.090AS	1/2"	4 - 6	21	6 x M6	3 x M4	*	3.5 x 3.8	4.94	ok	2,900

Accessory cutting balls



00420.0902		Locking pin	0.5
00420.0702		Locking pin for cutting ball Ø70	0.5
857.1230		Cylinder pin Ø 12x30	0.1

Impact milling cutters

These tools are a radical innovation for milling-off deposits in pipes. The enz® impact milling cutters are designed to remove the most stubborn deposits like concrete, injection cement, mineral deposits etc. They work with a percussion system of 600-3000 impulses per minute and up to 12 tons of impact force. Please ask for special equipment for plastic deposits! When using the pull rod (drawing device) the cutters can be driven with half the water quantity (from 200 mm).

Characteristics

- superior performance compared to other cutters
- extended tooth life
- easy handling
- low maintenance cost
- proven design

All impact milling cutters can be operated without impacts.



Impact milling cutters 1" - 1 1/4"



14.400	1", 1 1/4"	16	79	3 x M10	3 x M10	14.8 x 22.0	196.21	2,100
14.450	1", 1 1/4"	18	106	3 x M10	3 x M10	16.7 x 28.0	235.90	2,100
14.500	1", 1 1/4"	20	119	3 x M10	3 x M10	18.7 x 28.0	244.71	2,100
14.600	1", 1 1/4"	24	132	3 x M10	3 x M10	22.6 x 28.0	264.56	2,100







Accessory and wearing parts impact milling cutters



14.400K 	16	26.46
14.450K 	18	29.76
14.500K 	20	37.48
14.600K 	24	41.89
0014.3008 	12 - 24	14.88
14.K05 	8 - 24	0.44
15.ZKB 		1.32
14.400NA 	16 - 18	26.46

Impact milling cutters



				
14.500NA		Hub for impact drilling-cutter 19.7"	20	28.00
14.600NA		Hub for impact drilling-cutter 23.6"	24	28.00
0014.30011		Extension for the shaft of IM 300		0.99
14.450KU		Adapter plates for skids 17.7"	18 - 24	35.27
14.2215ZS		Pull-rod M22x1.5 x 8"	8 - 24	2.21

Recycling Milling cutters

The new impact milling cutter family called IMC can be used with recycling water. Due to a very high impact and the diamond or carbide teeth it's an excellent nozzle to remove hardest deposits such as concrete and limescale. You can use it with or w/out impact depending on the pipe material. Furthermore you can work in pipes from 100mm – 600mm (4"-24").

Advantages

- high performance due to high impact
- recycling water | less maintenance
- simple maintenance
- low cost to operate



IMC 1"



14.100R	1"	4	26	3 x M8	3 x M10	3.5 x 13.8	27.1	ok	2,900
14.120R	1"	5	31	3 x M8	3 x M10	4.4 x 13.8	30.20	ok	2,900
14.150R	1"	6	40	3 x M8	3 x M10	5.4 x 13.8	35.9	ok	2,900

IMC 1" - 1 1/4"



















14.200R	1", 1 1/4"	7.8	53	3 x M10	3 x M10	6.8 x 23.6	95.68	ok	2,900
14.225R	1", 1 1/4"	8.9	58.1	3 x M10	3 x M10	7.9 x 23.6	101.41	ok	2,900
14.250R	1", 1 1/4"	9.9	63.4	3 x M10	3 x M10	8.7 x 23.6	115.74	ok	2,900
14.300R	1", 1 1/4"	11.8	73.9	3 x M10	3 x M10	11.8 x 28	211.6	ok	2,900
14.350R	1", 1 1/4"	13.8	73.9	3 x M10	3 x M10	13.8 x 28	218.2	ok	2,900

Accessory and wearing parts IMC



0014.100D	Diamond crown	4	1.87
0014.120D	Diamond crown	5	2.42
0014.150D	Diamond crown	6	4.96
0014.200D	Diamond crown	8	6.61
0014.250D	Diamond crown	10	6.83

				
0014.300D		Diamond crown	12	15.65
0014.350D		Diamond crown	14	28.6
14.100KR		Milling Cutter Head for 3.9"	4	7.8
14.120KR		Milling Cutter Head for 120mm	5	7.8
14.150KR		Milling Cutter Head for 150mm	6	7.8
14.200KR		Impact drilling cutter head 7.9"	8	8.16
14.225KR		Impact drilling cutter head 8.9"	9	8.16
14.250KR		Impact drilling cutter head 9.8"	10	12.13
14.300KR		Impact drilling cutter head 11.8"	12	16.54
14.350KR		Impact drilling cutter head 13.8"	14	21.83
14.375KR		Impact drilling cutter head 14.76"	14.76	
15.ZD		Diamant tooth for impact cutter		0.17
15.Z1		Impact segment tooth for center		0.18
15.ZU		Universal tooth (all Ø)		0.18
15.Z1-100		Impact tooth for center for 14.100		0.13

15.ZU-GSL		Impact segment tooth for plastic 0.11
15.ZHU		Carbide tooth for impact cutter 0.24
15.ZKBR		Center cap with bored hole for drawbar 1.32
14.ZSR		Pull-rod M16 x 1.5 x 12.4
14.KR35W		Cam plate to Impact Milling Cutter Recycling 0.79
65212.08		Nord-Lock wedge lock washers M8 0.002
14.K04		Cam plate 0.15 inch per pc. with screws till 6 1.01
14.99001		Torque wrench Stahlwille 0.24
24.125S		Swivel joint with thrust jets 4.08
14.99002		Hex socket 3/4" SW 41 0.24
14.99003		Socket adapter 3/4" - 1/2" with magnet 0.24
14.99004		Hand lever grease gun Pressol 0.24
14.99008		Grease for Recycling

eBomb

enz® Camera – the camera nozzle with integrated data management

The enz® Camera Nozzle adds a new dimension to the enz® nozzle product range! The modular design allows universal use with all nozzle types, such as the eBomb or the eBulldog, and thus guarantees streak-free all-around cleaning in every application! The HD-ready resolution and 12 high-power LEDs deliver high-resolution video footage for quality control, documentation, and preliminary inspection. Data management is fully integrated into the system through the WiFi interface and connection to the enz® Cloud. All your manholes and channels are automatically mapped on Google Maps with the videos. The enz® Camera Nozzle, which is simple, fast, and robust, increases productivity without any negative impact on the cleaning performance or quality.



eBomb 1" - 1 1/4"



40.150iB	1"	6 - 16	40	10 x M10	10.4 x 3.7	20.2	ok	3,600
40.150iC	1 1/4"	6 - 16	40	10 x M10	10.4 x 3.7	20.2	ok	3,600

eBomb 1" - 1 1/4" with skid



40.250iB	1"	10 - 16	40	10 x M10	10.4 x 6.8	27.3	ok	3,600
40.250iC	1 1/4"	10 - 16	40	10 x M10	10.4 x 6.8	27.3	ok	3,600

eBomb 1" - 1 1/4" with skid (plastic skids)











40.250iPB	1"	10 - 16	40	10 x M10	10.4 x 6.8	27.3	ok	3,600
40.250iPC	1 1/4"	10 - 16	40	10 x M10	10.4 x 6.8	27.3	ok	3,600

Accessory and wearing parts eBomb



40.2504i		Cage for eBomb 250		10 - 16		6.6		
40.100iBW		eBomb (from 150)	1"	6 - 16	40	10 x M10	10.4 x 3.7 (6.8)	13 ok 3,600

										
40.2505i		Plastic skid for eBomb 250		10 - 16				4.4		

eBulldog

enz® Camera – the camera nozzle with integrated data management

The enz® Camera Nozzle adds a new dimension to the enz® nozzle product range! The modular design allows universal use with all nozzle types, such as the eBomb or the eBulldog, and thus guarantees streak-free all-around cleaning in every application!

The HD-ready resolution and 12 high-power LEDs deliver high-resolution video footage for quality control, documentation, and preliminary inspection. Data management is fully integrated into the system through the WiFi interface and connection to the enz® Cloud. All your manholes and channels are automatically mapped on Google Maps with the videos. The enz® Camera Nozzle, which is simple, fast, and robust, increases productivity without any negative impact on the cleaning performance or quality.



eBulldog 3/4" - 1 1/4"



402.200iA	3/4"	8 - 23	53	6 x M10	9 x M8	12.8 x 6.3 x 5.1	20	ok	2,900
402.200iB	1"	8 - 23	53	6 x M10	9 x M8	12.8 x 6.3 x 5.1	20	ok	2,900
402.200iC	1 1/4"	8 - 23	53	6 x M10	9 x M8	12.8 x 6.3 x 5.1	20	ok	2,900

eBulldog 3/4" - 1 1/4" large skids



402.300iA	3/4"	11.8 - 31.5	53	6 x M10	9 x M8	13.1 x 11.8	19.2	ok	2,900
402.300iB	1"	11.8 - 31.5	53	6 x M10	9 x M8	12.8 x 11.8	19	ok	2,900
402.300iC	1 1/4"	11.8 - 31.5	53	6 x M10	9 x M8	15 x 11.8	20.3	ok	2,900

Accessory and wearing parts eBulldog



100.2004i		Skid guidance for eBulldog					5.1 x 11.8	6.8	
402.060iB		eBULLDOG Rotating nozzle 2.4"	1"	53	6 x M10	9 x M8	5.8 x 2.3	4.63	ok 2,900
100.2005		Set of extension skids for eBulldog		11.8 x 31.5			12.4 x 11.8	4.9	

eBulldozer

enz® Camera – the camera nozzle with integrated data management









The enz® Camera Nozzle adds a new dimension to the enz® nozzle product range! The modular design allows universal use with all nozzle types, such as the eBomb or the eBulldog, and thus guarantees streak-free all-around cleaning in every application!

The HD-ready resolution and 12 high-power LEDs deliver high-resolution video footage for quality control, documentation, and preliminary inspection. Data management is fully integrated into the system through the WiFi interface and connection to the enz® Cloud. All your manholes and channels are automatically mapped on Google Maps with the videos. The enz® Camera Nozzle, which is simple, fast, and robust, increases productivity without any negative impact on the cleaning performance or quality.



eBulldozer 3/4" - 1 1/4"



									
50.075iG	3/4"	12 - 20	26	4 x M10, 2 x FanJet M10	1 x M10	15.8 x 8.6 x 9.2	26.46	ok	3,600
50.100iG	1"	16- 60	40	6 x M10, 2 x FanJet M10	1 x M10	20.1 x 10.8 x 10.6	56.22	ok	3,600
50.125iG	1 1/4"	20 - 100	79	6 x M10, 2 x FanJet M10	1 x M10	25.5 x 12.6 x 11.8	82.67	ok	3,600

Accessory and wearing parts eBulldozer



				
50.0755i		Mounting kit eScraper 3/4" incl. roll bar	9.1 x 8.7 x 7.7	12.1
50.1005i		Mounting kit eScraper 1" incl. roll bar	11.7 x 10.8 x 9.1	14
50.1255i		Mounting kit eScraper 5/4" incl. roll bar	14.3 x 12.6 x 9.3	14.6
50.07551i		Mounting kit eScraper 3/4" w/o roll bar		6.8
50.10051i		Mounting kit eScraper 1" w/o roll bar		6.8
50.12551i		Mounting kit eBulldozer 5/4" w/o roll bar		6.8









Camera pull nozzle

The new camera pull nozzle from enz® is compatible with most cameras on the market. It convinces with a very high cleaning and pulling performance. Due to the loss-proof screw and cover, the nozzle is extremely user-friendly. Furthermore, the enz® camera nozzle is curved, wear-resistant and easy to handle. The application range is 3" - 10".



Camera pull nozzle 3/8" NPT - 1/2"



								
230.050ZAN09	3/8" NPT	3 - 10	13	4 x M6	2.4 x 1.8	1.1	ok	3,600
230.050ZAN10	3/8" NPT	3 - 10	13	4 x M6	2.4 x 1.8	1.1	ok	3,600
230.050ZAN11	3/8" NPT	3 - 10	13	4 x M6	2.4 x 1.8	1.1	ok	3,600
230.050ZAN12	3/8" NPT	3 - 10	13	4 x M6	2.4 x 1.8	1.1	ok	3,600
230.050ZB09	1/2"	3 - 10	13	4 x M6	2.4 x 1.8	1.1	ok	3,600
230.050ZB10	1/2"	3 - 10	13	4 x M6	2.4 x 1.8	1.1	ok	3,600
230.050ZB11	1/2"	3 - 10	13	4 x M6	2.4 x 1.8	1.1	ok	3,600
230.050ZB12	1/2"	3 - 10	13	4 x M6	2.4 x 1.8	1.1	ok	3,600

Camera Nozzle Accessories











enz® Camera – the camera nozzle with integrated data management

The enz® Camera Nozzle adds a new dimension to the enz® nozzle product range! The modular design allows universal use with all nozzle types, such as the eBomb or the eBulldog, and thus guarantees streak-free all-around cleaning in every application!



Camera Nozzle Accessories



				
09.210080N		Case for camera	15.4 x 12.2 x 5.8	3.94
C290		Lens cleaner	1.6 x 5.7	0.33
C291		Lens polish	1.6 x 5.7	0.33
210.080		Enz® Camera	3 x 6.4	1.74
210.0801		Enz® Magnet	1.0 x 2.2	0.075
291.0801		Enz® Charging station	5.9 x 5.9 x 3.2	0.564
210.080-SET		Enz® Camera Set	3 x 6.4	7.26
0040.1005i		Blind cover		2.478





JetCam 4.0

Cleaning, inspecting, bending, and documenting in one operation! The camera nozzle is particularly well-suited for the simultaneous cleaning and inspection of municipal and private pipe systems thanks to its powerful cleaning performance and live image. The JetCam 4.0 cleans pipes from 50 mm–150 mm. Not only does the JetCam camera nozzle make it through multiple bends (even multiple 90° bends), but it also unclogs thanks to the front jet nozzle.



JetCam 4.0



					 max
220.02.038S	1/2"	2 - 6	24.76x19.68x32.76	122	2,600
220.02.050S	1/2"	2 - 6	24.76x19.68x32.76	130	2,300
220.02.050WDS	1/2"	2 - 6	24.76x19.68x32.76	139	2,300

JetCam 40 Pro





Cleaning, inspecting, bending, and documenting in one operation! The camera nozzle is particularly well-suited for the simultaneous cleaning and inspection of municipal and private pipe systems thanks to its powerful cleaning performance and live image. The JetCam 40 Pro cleans pipes from 50 mm–150 mm.

Not only does the JetCam camera nozzle make it through multiple bends (even multiple 90° bends), but it also unclogs thanks to the front jet nozzle.



JetCam 40 Pro



					 max
220.01.038S	1/2"	2 - 6	22x23x34	106	2,600
220.01.050S	1/2"	2 - 6	22x23x34	115	2,300
220.01.050WDS	1/2"	2 - 6	22x23x34	124	2,300











JetCam Accessories

The interchangeable nozzle set from enz® consisting of a standard nozzle, KBR, HRH nozzle, and a Rotopuls allows you to solve all problems such as grease, hair roots, or incrustations in household applications. Another big advantage of JetCam is that it saves resources on cleaning and properties no longer have to be cleaned from the outside in, rather than from the inside out.







JetCam Accessories





				
220.10111050		1/2" KBR rotation nozzle with extension	1.6x1.6x3.44	1.3
220.10111051		1/2" vibration nozzle with extension	1.6x1.6x3.44	1.2
220.1011805		Cleaning nozzle 12-jets WDS	1.44x1.44x1.68	1.3
220.1011806		1/2" HRH rotation nozzle with extension	1.6x1.6x3.44	1.3
220.1011928		Steeringpart WDS without nozzle	17.6x1.16x1.16	0.6
220.1011931		Cleaning nozzle 6-jets WDS	1.44x1.44x1.68	0.4
220.1011708		Steering part with rotation nozzle 3/8"	18x1.12x1.12	1.5
220.11045		JetCam Nozzle Set	16x12.4x6	8.8

JetCam Accessories



				
220.1001136		Powerbank for JC40	10.4x5.2x3.2	1.9
220.1001567		Impact guard for front jet	2.2x2.2x3.12	0.2
220.1011976		Extension 20 m for hp-hose 1/2"		14.3
220.1001421		Mugel JC40 (Impact guard)	2.24x2.24x2.84	0.2

				
220.1001044B		Forward jetting nozzle with impact guard	2.2x2.2x3.12	0.3

JET NOZZLE INSERTS

Ceramic nozzle inserts	123
Steel nozzle inserts	125





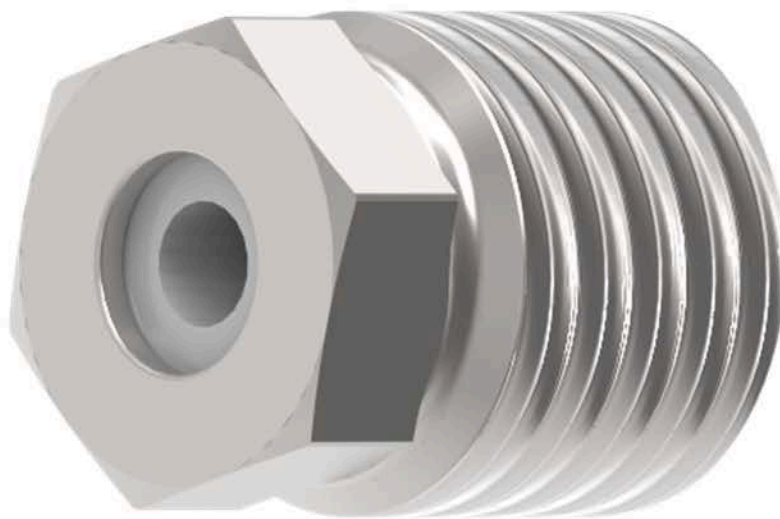



Ceramic nozzle inserts

These stainless steel ceramic inserts with flow straightener provide a very compact and aggressive water jet. The integrated jet stabilizer ensures a concentrated and powerful water jet density. The service life of a JetMax ceramic insert is much longer than that of hardened steel nozzles or other drilled inserts. Ceramic inserts are particularly suitable for use with recycled water.









Round jet



					 max
22.025		Ceramic insert Ø 0.4 - 0.16 inch	G 1/4"	0.022	7,250
22.04		Ceramic insert Ø 0,01 - 0,06 inch	M4	0.022	22,000
22.06		Ceramic insert Ø 0,01 - 0.2 inch	M6	0.022	14,500
22.08		Ceramic insert Ø 0,04 - 0.13 inch	M8	0.022	22,000
22.10		Ceramic insert Ø 0,04 - 0,15 inch	M10 x 1	0.022	22,000

Fan jet







						 max
22.08F		Ceramic insert fan jet	M8	30°	0.022	7,250
22.10F		Ceramic insert fan jet	M10 x 1	30°	0.022	7,250
22.025F		Ceramic insert fan jet	G 1/4"	30°	0.033	7,250

Steel nozzle inserts

These steel inserts stand out from the competition. These inserts have an excellent price-performance ratio. They are more durable than sapphire inserts, but they have a shorter service life. Unlike ceramic inserts, they are not suitable for use with recycled water. We commonly see them in the water jetting industry and recommend them for use in this industry, particularly with clean water.



Steel nozzle inserts

				 max
22S03		Steel inserts, hardened, M3 Ø 0.3 - 1.2 mm	0.028	44,000
22S04		Steel inserts, hardened, M4 Ø 0.3 - 1.2 mm	0.028	44,000

ACCESSORIES

Bushings and extensions	129
Swivel joints	132
Spray guns	134
Hose protection and accessories	137
Nozzle extension and accessories	140
High pressure hoses and accessories	142
Pull part for high pressure hoses	144
Maintenance	146
Toolboxes	148





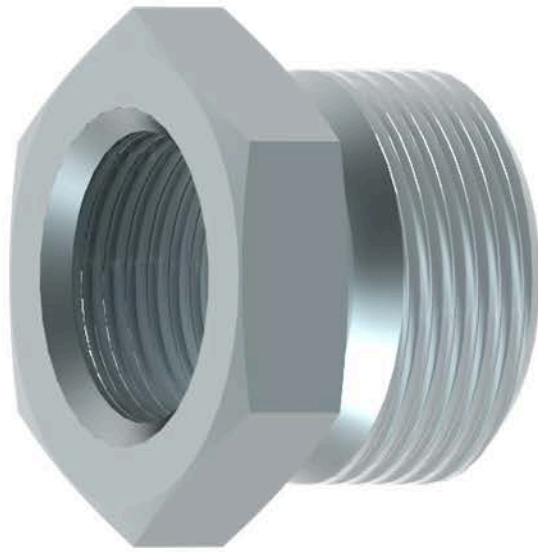





Bushings and extensions

enz® expansions (extensions) and reductions of various thread sizes are all made of stainless steel.



Bushings











				
19.M050F025N		Reduction bushing M 1/2" F 1/4" NPT	m 1/2 - f 1/4	0.11
19.M075F050		Reduction bushing M 3/4" F 1/2"	m 3/4 - f 1/2	0.26
19.M100F050		Reduction bushing M 1" F 1/2"	m 1 - f 1/2	0.22
19.M100F062		Reduction bushing M 1" F 5/8"	m 1 - f 5/8	0.28
19.M100F075		Reduction bushing M 1" F 3/4"	m 1 - f 3/4	0.34
19.M125F100		Reduction bushing M 1 1/4" F 1"	m 1 1/4 - f 1	0.34
19.M150F100		Reduction bushing M 1 1/2" F 1"	m 1 1/2 - f 1	0.4
19.M150F125		Reduction bushing M 1 1/2" F 1 1/4"	m 1 1/2 - f 1 1/4	0.4

Extensions



				
19.M050F062		Extension bushing M 1/2" F 5/8"	m 1/2 - f 5/8	0.29
19.M050F075		Extension bushing M 1/2" F 3/4"	m 1/2 - f 3/4	0.29

				
19.M050F100		Extension bushing M 1/2" F 1"	m 1/2 - f 1	0.49
19.M075F100		Extension bushing M 3/4" F 1"	m 3/4 - f 1	0.52
19.M100F125		Extension bushing M 1" F 1 1/4"	m 1 - f 1 1/4	1.2
19.M100F150		Extension bushing M 1" F 1 1/2"	m 1 - f 1 1/2	1.3
19.M100F40		Extension bushing M 1" F M40x2"	m 1 - f M40x2	0.78
19.M125F150		Extension bushing M 1 1/4" F 1 1/2"	m 1 1/4 - f 1 1/2	1.3









Swivel joints

Rustproof, sturdy execution, smooth operation, with excellent flow dynamic, suitable for larger channel cleaning and for operating cutters.



Swivel joints 1/2" - 1 1/4"



						 max
24.050		Swivel joint	1/2" m - 1/2" f	1.65 x 3.15	1.17	3,600
24.075		Swivel joint	3/4" m - 3/4" f	2.32 x 2.91	2.70	3,600
24.100		Swivel joint	1" m - 1" f	2.95 x 3.15	4.85	3,600
24.125		Swivel joint	1 1/4" m - 1 1/4" f	2.36 x 4.76	3.02	3,600
24.150		Swivel joint	1 1/2" m - 1 1/2" f	3.31 x 3.78	5.95	3,600

Spray guns

Enz has multiple range of spray guns in its program. The jet can change from a pointed to flat jet, where you can trigger the flow very slowly or you can use a maximum flow. This can accommodate water temperatures of up to 150 °C.



Spray guns















18.42		Spray gun with swivel SG-42	3/8"	2.6	46.5 x 7.9 x 1.8	3.97	-	4,350
18.43		Spray gun with swivel SG-43	1/2"	2.6	43.3 x 7.9 x 1.8	4.63	ok	5,000
18.44		Spray gun with swivel SG-44	1/2"	2.6	42.1 x 7.9 x 1.8	4.19	-	2,900
18.45		Spray gun without swivel SG-45	1/2"	2.6	30.7	5.07		3,600
18.41		Spray gun with swivel SG-41	1/2"	2.6	37.4 x 7.9 x 1.8	2.65	-	4,350

Accessories for spray guns



22S025N17		Steel insert Ø 1.7mm	AG 1/4" NPT	0.07	
22S025N27		Steel insert Ø 2.7mm	AG 1/4" NPT	0.07	
22S025N17F40		Steel insert fan jet Ø 1.7mm	AG 1/4" NPT	0.07	
22S025N13		Steel insert Ø 1.3mm	AG 1/4" NPT	0.07	
22S025N21		Steel insert Ø 2.1mm	AG 1/4" NPT	0.07	
0018.4543		Nozzle for lance Vario Ø 3.0mm		0.3	
0018.4542		Nozzle for lance Vario Ø 2.0mm		0.3	
08.0501		Pistol nozzle with round jet	1/2"		8,700
08.0502		Pistol nozzle with flat jet	1/2"		8,700

					
08.0751		Pistol nozzle with round jet	3/4"		5,000
08.0752		Pistol nozzle with flat jet	3/4"		5,000
08.1001		Pistol nozzle with round jet	1"		3,600
08.1002		Pistol nozzle with flat jet	1"		3,600
0018.438		Shoulder support for SG-43 13.4-19.7"		1.5	
0018.453		Spray gun Vario		1.5	
0018.429		Repair kit to spray gun SG-41 SG-42 SG-44			
08.0551	<td>Lance head drilled Ø 5 mm - 1/2 "</td> <td>1/2"</td> <td></td> <td>5,000</td>	Lance head drilled Ø 5 mm - 1/2 "	1/2"		5,000
0018.4599		Repair kit to spray gun SG-45			
0018.439		Repair kit to spray gun SG-43			
0018.050		Swivel joint for spray gun	1/2"		8,700

Hose protection and accessories

enz® hose protection provides optimum protection for the hose's rubber or plastic coating against environmental influences. In addition to protective plastic hoses, enz® also sells rigid and flexible flex guides. Compared to traditional deflection slides and the plastic hose protection that cause heavy wear on the hoses, the rollers on the enz® flex guides last five times longer. These flex guides are also available in a flexible variant so that you do not always have to detach the nozzle.



Hose protection

















91M		Steel-Banane small	5.1+	11.81 x 14.57	5.6
91		Steel-Banane middle	6.7+	13.78 x 17.72	9.46
91A		Steel-Banane big	6.7+	23.62 x 26.38	11.88
91.05B		Flex guide for hoses with fix hanger	6.7+	18.23 x 5.2 x 8.98	15.43
91.07B		Flex guide for hoses with fix hanger	6.7+	22.8 x 5.2 x 10	20.28
91.05M		Flex guide	4.3+	3.15 x 11.81	4.28
91.05		Flex guide for hoses with brackets	8.3+	18.23 x 5.2 x 8.98	15.43
91.07		Flex guide for hoses with brackets	8.3+	22.8 x 5.2 x 10	20.28
92		High vac. protective plastic hose	5.9+	3.1#4.0 x 35.5	5.5
92A		High vac. protective plastic hose	3.5+	2.0#2.5 x 35.5	3.0

Accessories for hose protection



0090.02		Extension with locking spring	4.5
0090.03		Quick-Lock complete	4.68
0090.10		Locking sprong for extension	

			
0090.40		Shaft to plastic wheel Ø 20 x 122	
0090.90		Plastic wheel red	
0091.0504		Towing eyelet	
0091.0515		Adapter for flex guide hoses	
0091.0514M		Plastic protection	
0091.0504M		Towing eyelet	
0091.0505M		Roll	
93.7		Rope clip for upper deflection device	0.02
91.0515		Flex guide for hoses 91.05	
91.0715		Flex guide for hoses 91.07	
0091.05700		Roller alu with bearing	
0091.05703		Plastic protection for flex guide	
90		Deflection device for lower edge	
93		Deflection device 18 - 34 inch	

Nozzle extension and accessories

The enz® Nozzle extension are based on a pipe-in-pipe solution and are designed in such a way that the threads cannot be screwed in with too much force. This has no impact on the water output. In many countries, it is actually mandatory to use Nozzle extension in order to prevent serious accidents during work.



Nozzle extension and accessories



97.050-100		Safetyliner complete 1/2" - 1/2"	1/2"	max. 7.8	1.06 x 4.57	0.70	ok	7,500
97.050-150		Safetyliner complete 1/2" - 1/2"	1/2"	max. 11.7	1.06 x 6.52	0.9	ok	7,500
97.075-100		Safetyliner 3/4" - 3/4"	3/4"	max. 7.8	1.37 x 4.65	1.0	ok	7,500
97.075-200		Safetyliner 3/4" - 3/4"	3/4"	max. 15.6	1.37 x 8.55	1.6	ok	7,500
97.100-150		Safetyliner 1" - 1"	1"	max. 11.7	1.8 x 6.76	2.1	ok	5,000
97.100-200		Safetyliner 1" - 1"	1"	max. 15.6	1.8 x 8.71	2.6	ok	5,000
97.100-300		Safetyliner 1" - 1"	1"	max. 23.4	1.8 x 12.61	3.5	ok	5,000
97.125-150		Safetyliner 1 1/4" - 1 1/4"	1 1/4"	max. 11.7	2.08 x 6.84	1.2	ok	5,000
97.125-200		Safetyliner 1 1/4" - 1 1/4"	1 1/4"	max. 15.6	2.08 x 8.79	3.5	ok	5,000
97.125-300		Safetyliner 1 1/4" - 1 1/4"	1 1/4"	max. 23.4	2.08 x 12.7	4.7	ok	5,000

Threaded ring



0097.0503		Threaded ring 1/2"	1/2"	1.18 x 0.39	0.07	5,000

High pressure hoses and accessories

enz® high pressure hoses were developed for high and ultra high pressure applications. They combine outstanding handling and a long service life with the highest level of safety. When working with short nozzles, short fittings are important in order to pass through all the bends, while enz® reels allow you to work in a tidy and efficient manner within buildings.



High pressure hoses



						 max
C175N		HP hose	1/8" M NPT - 1/4" F NPSM	3/16" x 22yards Ø In 0.19" Ø Out 0.35"	4.54	5,000
C176N-30		HP hose	1/4" M NPT - 1/2" F" BSP	1/4" x 33yards Ø In 0.24" Ø Out 0.47"	11.46	5,000
C174N		HP hose	1/8" M NPT - 1/4" F NPSM	3/16" x 16yard Ø In 0.19" Ø Out 0.35"	3.39	5,000

Accessories for high pressure hoses



A-22MF-08BM KAE		Hand adapter IG M22x1.5-AG 1/2"		0.33
A-22MF-04BM KAE		Hand adapter IG M22x1.5-AG 1/4"		0.22
C330		Hose Reel for Hose 1/4" and 1/8"	1/2"	9.7
C331		Closure cap	1/4"	0.22
C332		Closure cap	1/8"	0.22

Pull part for high pressure hoses

The pulling part pulls the high pressure hose with cleaning tool into the sewer. It also enables the combination of several high-pressure hoses. This allows cleaning work to be carried out over long distances. On steep slopes, the pulling part can also be used as an additional push nozzle.

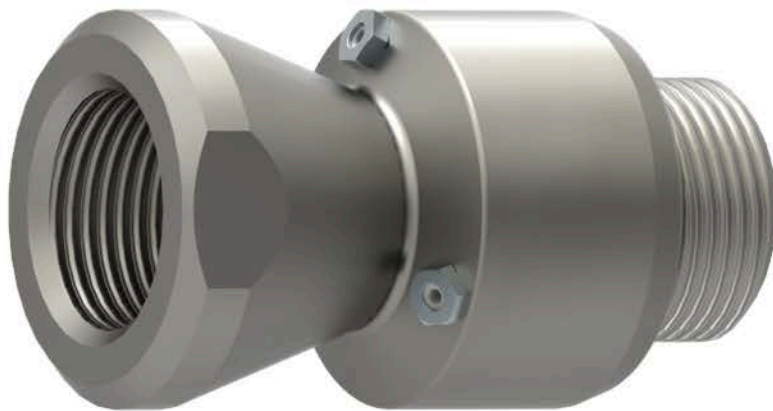







Pull part for high pressure hoses



Pull part for high pressure hoses



							 max
30.050Z		Pull part	1/2"	1.38	1.18 x 2.05	0.45	5,000
30.125Z		Pull part	1 1/4" - 1 1/4"	2.56	2.36 x 3.54	1.9	3,600
30.125100Z		Pull part	1 1/4" - 1"	2.56	2.36 x 3.74	1.9	3,600





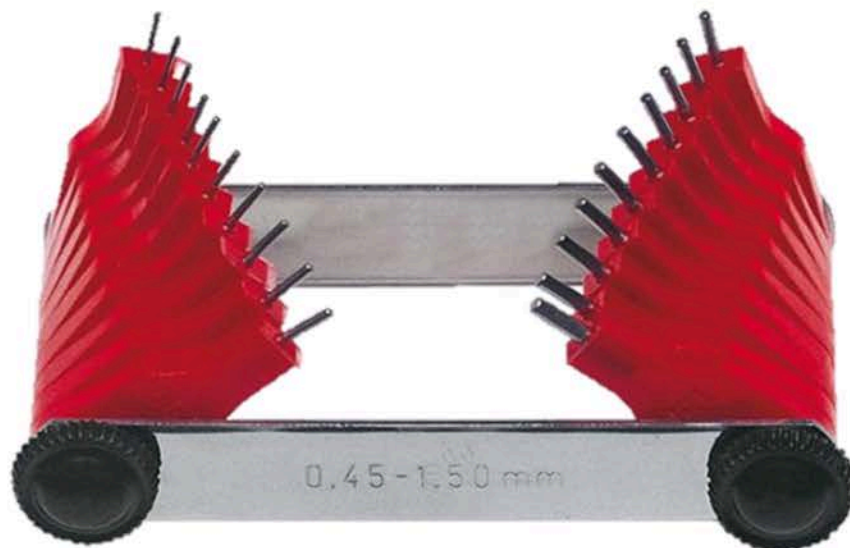











Maintenance

Regular maintenance and cleaning the nozzles daily prevents interruptions in operations and extends the service life of the nozzles. enz® sells various tools and products that come in handy when doing so. Reamers should never be used for cleaning.



Maintenance tools & nozzle care



		
C101		Socket wrench 0.2 inch 0.11
C149		Socket wrench 0.2 inch 0.15
C261		Socket wrench 3.5 mm 0.11
C260		Socket wrench Futuro 0.28 inch 0.15
C104		Socket wrench 0.2 inch 0.15
C131		Socket wrench cross handle 0.4 inch 0.05
C160		Socket wrench cross handle 0.3 inch 0.11
C205		Nozzle Maintenance Set 0.96
C200		Nozzle gauge 0.66
C201		Nozzle gauge 0.44
C202		Set Nozzle Cleaning-Tool 0.06
C191		Oil Spray Bio, 500 ml 1.1
C109		Loctite 638 - 50 ml / 1.69 oz 0.15
C192		Loctite 243 - 50 ml / 1.69 oz 0.15
C227		Loctite 270 - 50 ml / 1.69 oz 0.15











Toolboxes

Enz gives you the option to have a nozzle tool kit box for every jetter and water jetting truck. It's very flexible with the different types of nozzles and you can also add your logo on the lid. This option of organization can reduce the risk of lost or misplaced nozzles.



Toolboxes 1/8" - 1 1/4"



					
09.000012B		Box for 1/8" nozzles	1/8"	4.7 x 4.6x 1.6	0.23
09.000025B		Box for 1/4" nozzles	1/4"	4.7 x 4.6x 1.6	0.23
09.000038E		Case for 1/4" or 3/8" nozzles	1/4", 3/8"	10 x 8.3 x 2.4	0.78
09.000050F		Case for 1/2" nozzles	1/2"	10.04 x 8.26 x 2.36	1.32
09.001		Tool Case 1/2"	1/2"	11.81 x 10.83 x 4.13	1.10
09.003		Tool Case 3/4"	3/4"	15.35 x 11.81 x 7.28	4.19
09.004		Tool Case 1"	1"	19.49 x 16.14 x 7.09	6.17
09.005		Tool Case 1 1/4"	1 1/4"	19.67 x 16.54 x 6.89	6.17

For more information
www.enz.com



Article 402.200iA/B/C

Pump Datas

Flow rate 300.0 l/min
 Pressure 100.0 bar

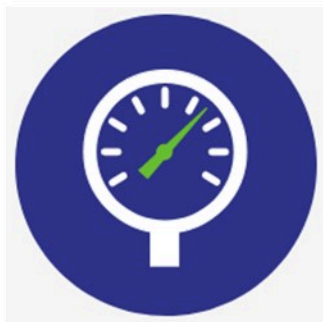

Hose system

Without hose

Calculated values

Flow rate 297.5 l/min
 Final pressure 100.0 bar
 Pressure loss 0.0 bar
 Traction approx. 57 kg
 Excess 2.5 l/min

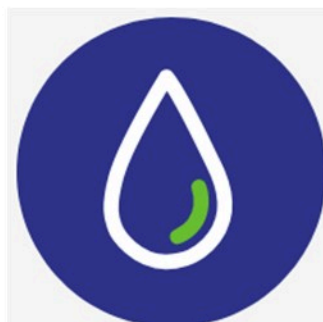

Equipment
 A = 3 x 2.0 mm
 B = 3 x 1.2 mm
 S1 = 3 x 1.7 mm
 S2 = 6 x 1.9 mm

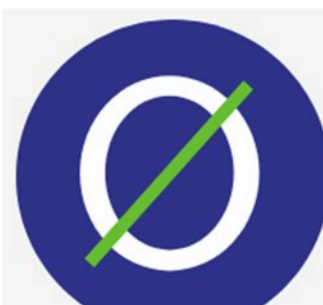

Advice(s) All rotating tools must be tested!

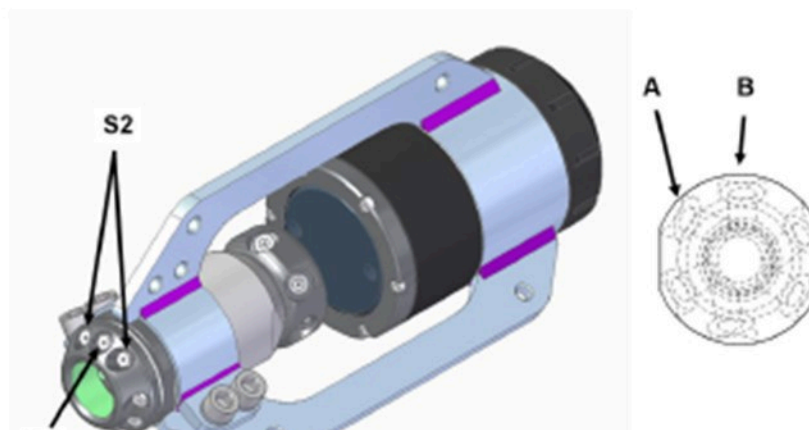

enz® usa inc.
1585 Beverly Ct.
Unit 115
Aurora, IL 60502
Phone 630-692-7880
Fax 630-692-7885
salesusa@enz.com
www.enz.com

